



ENG

TL-LD620-R

RAPIDMICRO™

Manual

Before using the light, read this manual thoroughly and keep it for future reference.



Design Pat. Pending
Copyright © 2021 CATEYE Co., Ltd.
TLLD620R-211006 3

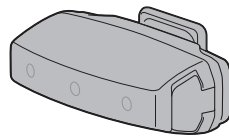

Light unit



Bracket rubber pad

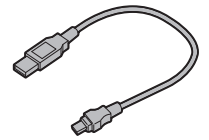

(MICRO USB)
USB cable

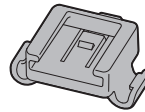

(SP-14-R)
Bracket

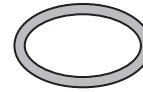

Rubber band

1 HOW TO CHARGE

! Always charge the product before use.

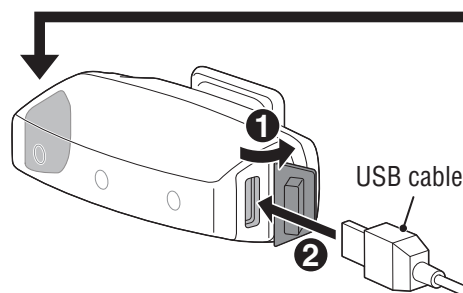

To PC or USB battery charger

Switch (Indicator)



Charging



Charging is
completed

Standard
charging time

Approx. **2 h**
(USB 2.0)

! WARNING!!!

- Check periodically to ensure that the light unit is attached securely. Do not use a damaged rubber band.
- Always attention to the remaining battery power by checking the indicator periodically while using.

! CAUTION!

- Stop your bicycle to operate the switch.
- Do not place it within children's reach.
- This unit is not totally waterproof. Please wipe and dry it completely after using in rain. Otherwise, it may cause failure.
- If the light unit or parts become dirty with mud, etc., clean with a soft cloth which is moistened with mild soap. Never apply paint thinner, benzene or alcohol; damage will result.

! LITHIUM-ION BATTERIES

Cautions on recharging

- We recommend using 500+mAh (USB2.0) USB battery charger.
- Avoid charging in direct sunlight or in a vehicle parked under direct sunlight, and make sure to charge only when the ambient temperature is between 41°F and 104 °F (5 and 40°C).
- Before charging, be sure that no dust or other foreign objects attach to the USB plug.
- Do not subject the light to vibrations while charging.
- When your PC is in sleep state, the unit cannot be charged.
- Once charging is complete, be sure to disconnect the USB plug.
- Charging time is approximate values, and will vary depending on the environmental and usage conditions.

Cautions in use

- Charging, discharging, and storing in high temperatures will cause the rechargeable battery to deteriorate faster. Do not place the light inside a vehicle or near a heater.
- If the illumination time is significantly reduced even after proper charging, the rechargeable battery may be nearing the end of its service life. Dispose of the battery as described in "Cautions for dispose".

Cautions on storage

Cool and dry storage is recommended. For long period storage, it is important to charge the battery 30 minutes every 6 months.

Cautions for dispose

When disposing of the light unit, remove the internal rechargeable battery and dispose of it according to local regulations.

2 HOW TO MOUNT

Attach securely in the mounting position.

Bracket rubber pad

Rubber band

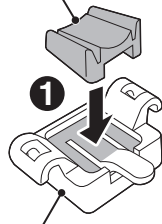

Bracket

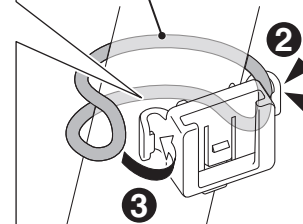

Ø21.5 – 32 mm

Horizontal

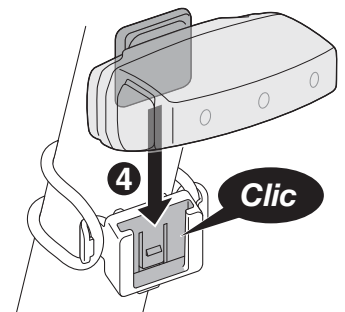

Vertical

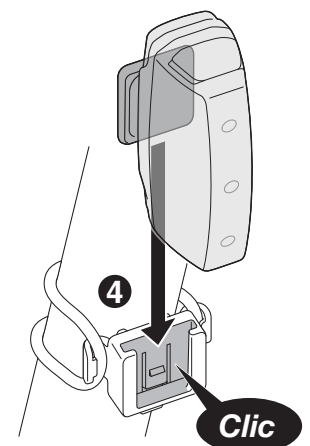

OPTION : Clip (C-2)

Clip

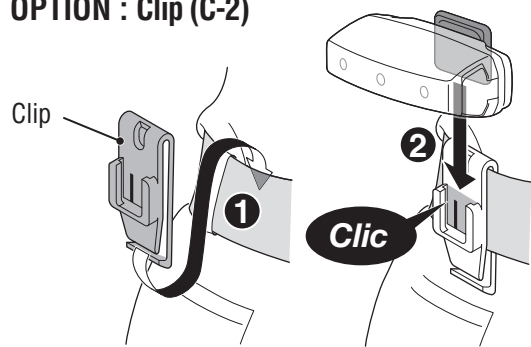

3 SWITCH OPERATION

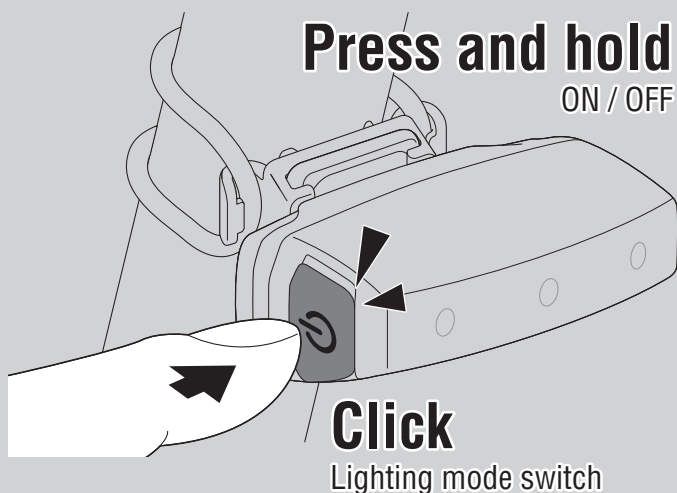

ON ↔ OFF

Press and hold

Lighting mode switch

Click

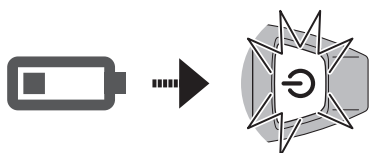
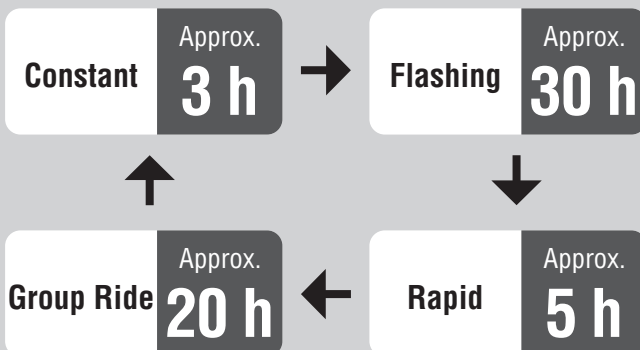

Automatic battery-saving function

When the remaining battery power is low, the lighting mode switch starts flashing and the lighting mode changes to flash. Charge the light as soon as possible.

SPARE / OPTIONAL PARTS

5342450

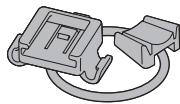

(SP-14-R)
Bracket

5342730

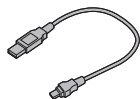

(MICRO USB)
USB cable

5342460

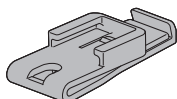

(C-2)
Clip

SPECIFICATIONS

- Battery : Rechargeable lithium-ion battery (320 mAh)
- Temperature range : 14°F – 104°F (-10°C – 40°C)
- Recharge/discharge number of times : About 300 times (until the rated capacity drops to 70%)
- Dimensions/weight : 2-3/64" x 25/32" x 1-17/64" (52 x 20 x 32 mm) / 0.76 oz (21.5 g)

* The specifications and design are subject to change without notice.

LIMITED WARRANTY

2-year Warranty:

Light unit only (excludes battery deterioration)

CatEye products are warranted to be free of defects from materials and workmanship for a period of 2 years from original purchase. If the product fails to work during normal use, CatEye will repair or replace the defect at no charge. Service must be performed by CatEye or an authorized retailer. To return the product, pack it carefully and enclose the warranty certificate (proof of purchase) with instruction for repair. Please write or type your name and address clearly on the warranty certificate. Insurance, handling and transportation charges to CatEye shall be borne by person desiring service.

For UK and REPUBLIC OF IRELAND consumers, please return to the place of purchase. This does not affect your statutory rights.

CATEYE CO., LTD.

2-8-25, KUWAZU, HIGASHI SUMIYOSHI-KU, OSAKA, JAPAN 546-0041
For inquiries, please visit <https://cateye.com/intl/contact/>

[For US Customers]

Please visit <https://www.cateyeamerica.com/contact-us/>
Toll Free : 800.5.CATEYE