



CATEYE VELO WIRELESS+



CYCLOCOMPUTER CC-VT235W



- This instruction manual is subject to change without notice. See our website for the latest instruction manual (PDF).
- Please visit our website, where a detailed Quick Start manual containing videos can be downloaded.

<http://www.cateye.com/products/detail/CC-VT235W/manual/>



Mounting the
computer



1

Setting up the
computer



2

Starting
measurement



3

Changing settings



4

Warning/Caution
Product Warranty, etc.

Appendix

Mounting the computer

1

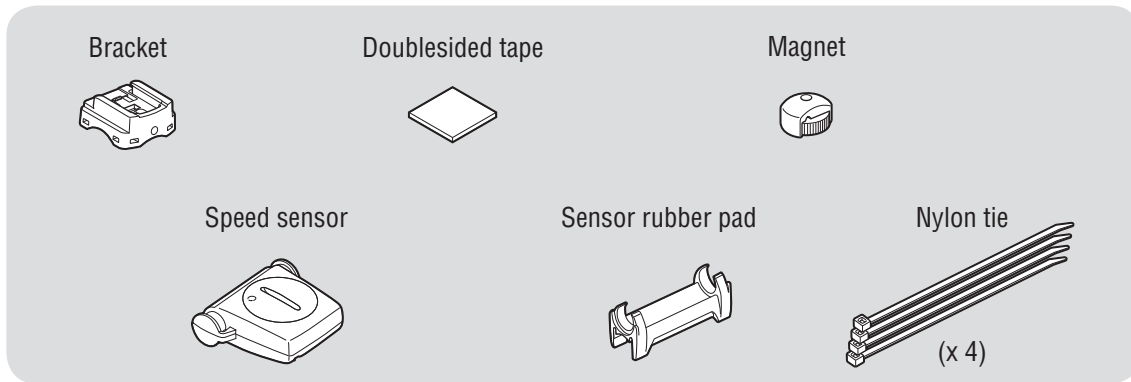

2



1 Mount the bracket

- When mounting on stem

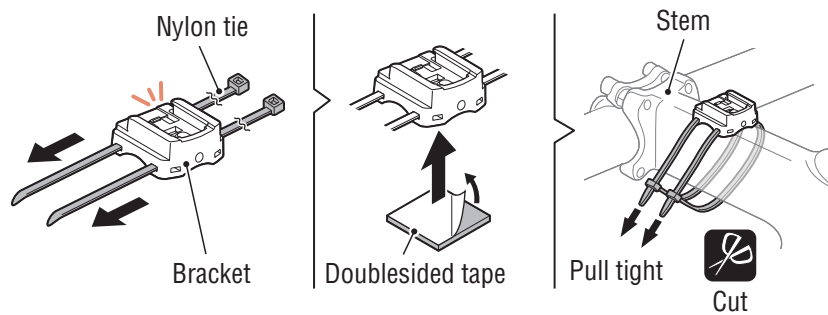
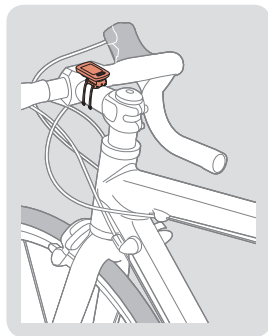

3



- When mounting on handlebar

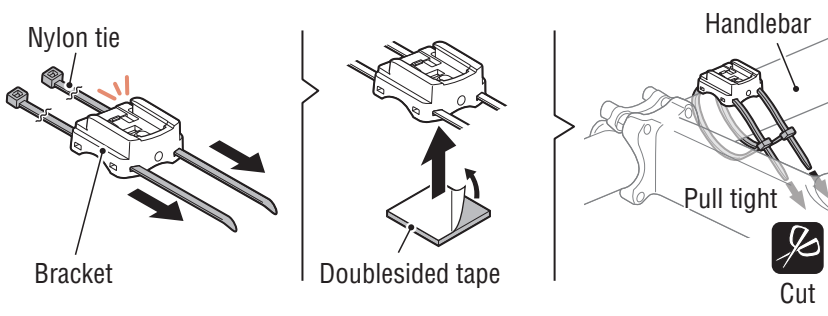
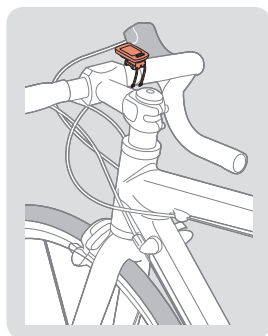

4



! When mounting the bracket on a handlebar, adjust the angle of the bracket so that the back of the computer faces the speed sensor when the computer is attached.

Correct

Wrong

Appendix

Mounting the computer

1



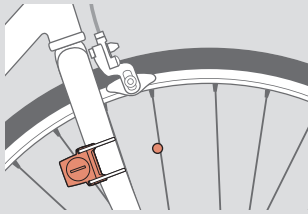

2 Mount the speed sensor

- Mounting on right front fork

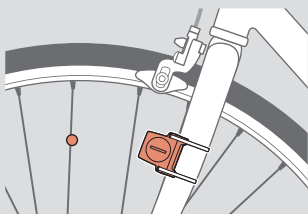

- Mounting on left front fork



 **Mount the speed sensor in a position where the distance from the computer to the speed sensor is within the signal range.**

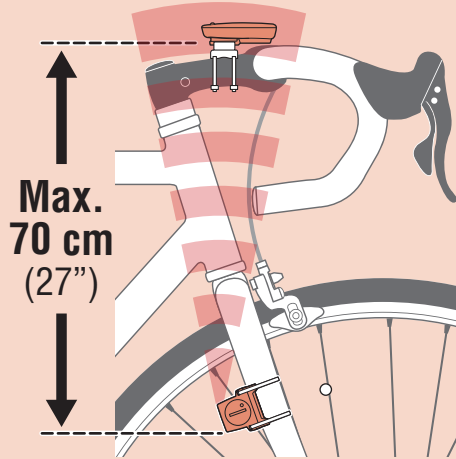

2



3

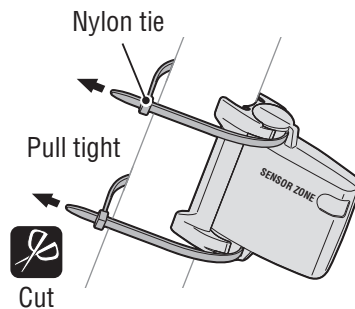
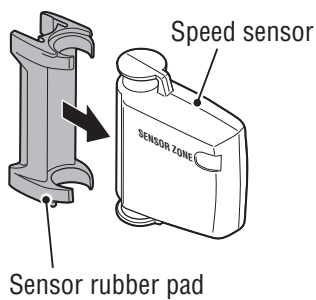

3 Mount the magnet

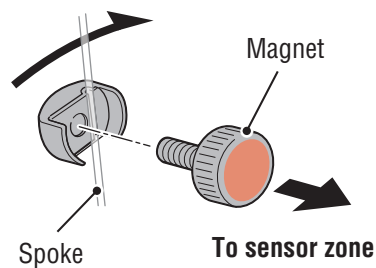
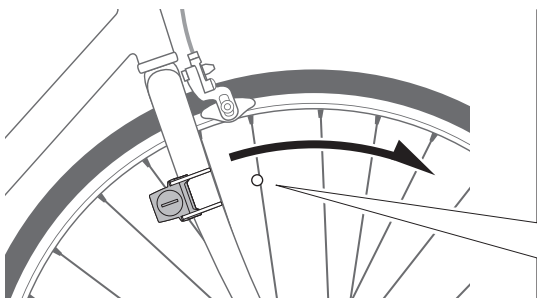

4



Appendix

Mounting the computer

1



4 Adjust the speed sensor and the magnet

 The magnet passes through the speed sensor zone.

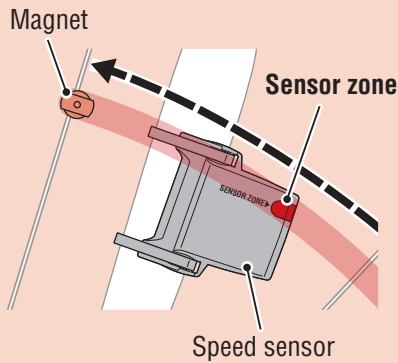

 The clearance between the speed sensor and the magnet is within 5 mm (3/16").

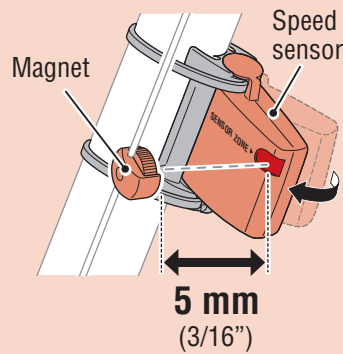

* The magnet may be mounted at any position on spoke as long as attachment conditions are satisfied.

2



5 Attach/detach computer

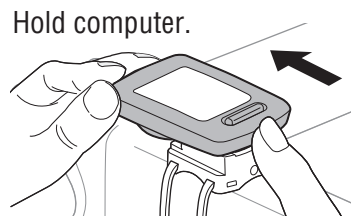
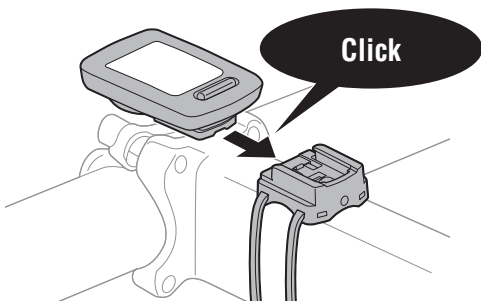

Push out so that front lifts up.

3



6 Test operation

After attaching the computer, rotate the front wheel gently to check that current speed is displayed on the computer.

If the speed is not displayed, refer to the attachment conditions in steps 1, 2, and 4

 again.

4



Appendix

Setting up the computer

1



When using the computer for the first time or resetting it to its factory default settings, clear all computer data following the procedure below.

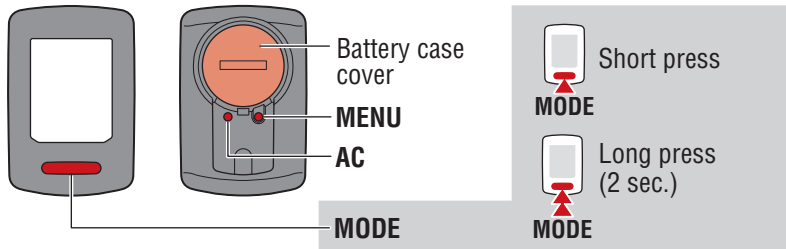

2



1 Clear all data.

Press the **AC** button on the back of the computer.

* All data is deleted and the computer is reset to its factory default settings.

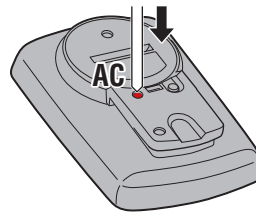

2 Select the measurement unit.

Select "km/h" or "mph".

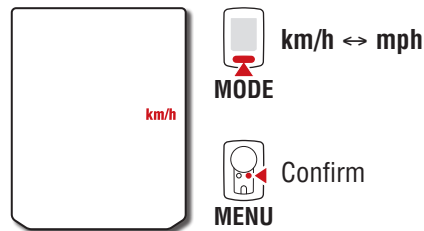

3



3 Select the tire size.

Simple setting:

When **MODE** is pressed, 26" → 700C → 27" → 27.5" → 29" → 205[] → 16" → 18" → 20" → 22" → 24" and 26" will appear, in this order.

Select the tire size (inch) of your bicycle.

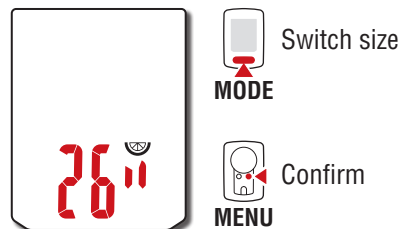

4



Advanced settings

(For more accurate measurement):

Display 205[] on the screen, and press and hold **MODE** to enter the tire size of your bicycle in cm. Pressing **MODE** changes the value, and pressing and holding **MODE** moves to the next digit.

* For details on the tire circumference, see "Tire circumference" (page 7).

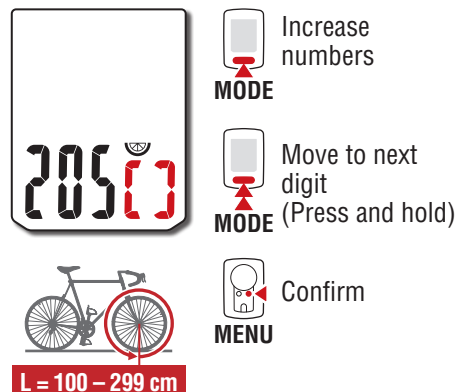

Appendix

Setting up the computer

1



4 Set the clock.

Each time the **MODE** button is pressed and held, settings switch from time display mode, to hours, to minutes.

* When **12h** is selected, **A** (AM) or **P** (PM) is displayed at the top of the screen.

Time display mode (**24h** or **12h**)

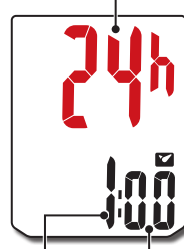

Switch item or increase numbers



Switch screen or move to next digit (Press and hold)

Hours Minutes

2



5 Press MENU to complete setup.

Setup is completed and the computer switches to the measurement screen. For instructions on how to start measurement, refer to “Starting measurement” (page 8).



MENU

Setup complete

3



4



Appendix

Setting up the computer

1



Tire circumference

Tire circumference can be determined by either of the following two methods:

- Measure the actual tire circumference (L)
After ensuring that the tire pressure is appropriate, sit on your bike, roll it forward so that the tire makes one full revolution (use the valve or other marking as a reference), and measure the distance traveled on the road.
- Tire size chart
* The tire size or ETRTO code is indicated on the side of the tire.



2



ETRTO	Tire size	L (cm)
40-254	14x1.50	102
47-254	14x1.75	110
40-305	16x1.50	119
47-305	16x1.75	120
54-305	16x2.00	125
28-349	16x1-1/8	129
37-349	16x1-3/8	130
32-369	17x1-1/4 (369)	134
40-355	18x1.50	134
47-355	18x1.75	135
32-406	20x1.25	145
35-406	20x1.35	146
40-406	20x1.50	149
47-406	20x1.75	152
50-406	20x1.95	157
28-451	20x1-1/8	155
37-451	20x1-3/8	162
37-501	22x1-3/8	177
40-501	22x1-1/2	179
47-507	24x1.75	189
50-507	24x2.00	193
54-507	24x2.125	197
25-520	24x1(520)	175
	24x3/4 Tubular	179
28-540	24x1-1/8	180
32-540	24x1-1/4	191
25-559	26x1(559)	191
32-559	26x1.25	195
37-559	26x1.40	201
40-559	26x1.50	201
47-559	26x1.75	202
50-559	26x1.95	205
54-559	26x2.10	207
57-559	26x2.125	207
58-559	26x2.35	208
75-559	26x3.00	217

ETRTO	Tire size	L (cm)
28-590	26x1-1/8	197
37-590	26x1-3/8	207
37-584	26x1-1/2	210
	650C Tubular 26x7/8	192
20-571	650x20C	194
23-571	650x23C	194
25-571	650x25C 26x1(571)	195
40-590	650x38A	213
40-584	650x38B	211
25-630	27x1(630)	215
28-630	27x1-1/8	216
32-630	27x1-1/4	216
37-630	27x1-3/8	217
40-584	27.5x1.50	208
50-584	27.5x1.95	209
54-584	27.5x2.1	215
57-584	27.5x2.25	218
18-622	700x18C	207
19-622	700x19C	208
20-622	700x20C	209
23-622	700x23C	210
25-622	700x25C	211
28-622	700x28C	214
30-622	700x30C	215
32-622	700x32C	216
	700C Tubular	213
35-622	700x35C	217
38-622	700x38C	218
40-622	700x40C	220
42-622	700x42C	222
44-622	700x44C	224
45-622	700x45C	224
47-622	700x47C	227
54-622	29x2.1	229
56-622	29x2.2	230
60-622	29x2.3	233

3



4



Appendix

Starting measurement [Measurement screen]

1



Night mode icon

This turns on when night mode is enabled. For details, see “Backlight (night mode)” (page 9).

Sensor signal icon

Flashes in sync with a sensor signal.

Pace arrow

Indicates whether the current speed is faster (▲) or slower (▼) than the average speed.

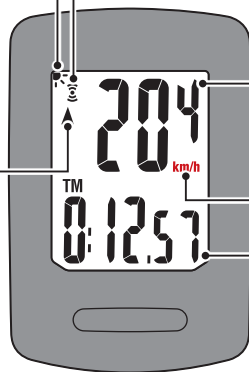

Current speed

0.0 (4.0) – 105.9 km/h
[0.0 (3.0) – 65.9 mph]

Measurement unit

Current function

Switching current function

Pressing **MODE** switches the current function displayed at the bottom of the screen.

2

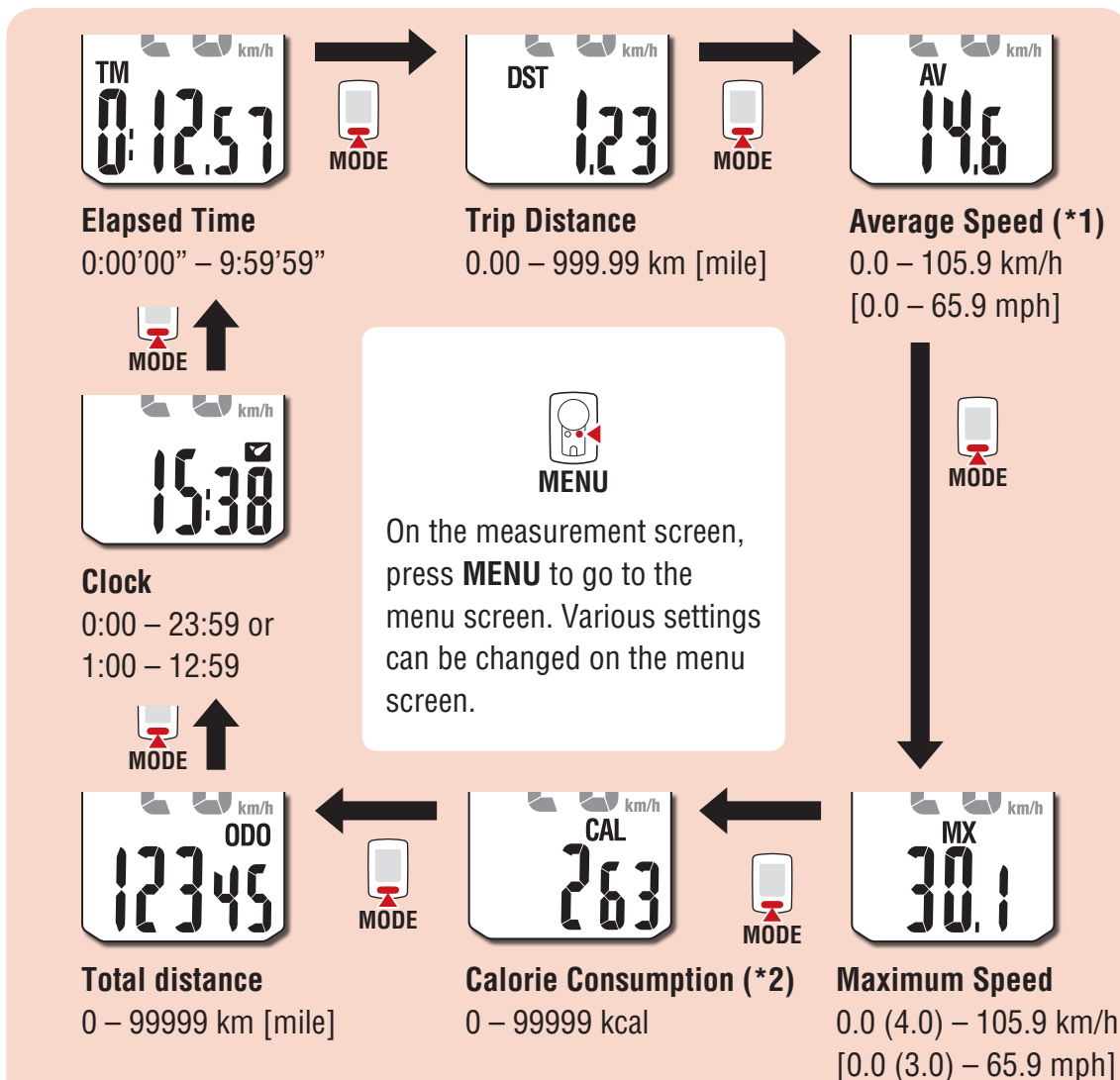

3



4



*1: Av (Average Speed) displays .E instead of the measurement value when Tm (Elapsed Time) exceeds approximately 27 hours or Dst (Trip Distance) exceeds 999.99 km. Reset the measurement data.

*2: Calorie consumption is a cumulative value based on speed calculated at one second intervals. Values for calorie consumption per hour are shown below.

Use the values in this chart as a reference.

Speed	10 km/h [mph]	20 km/h [mph]	30 km/h [mph]
Kcal per hour	67.3 kcal [155.2 kcal]	244.5 kcal [768.2 kcal]	641.6 kcal [2297.2 kcal]

Starting measurement [Measurement screen]

1

Starting/stopping measurement

Measurement starts automatically when the bicycle moves.

During measurement the measurement unit (km/h or mph) flashes.

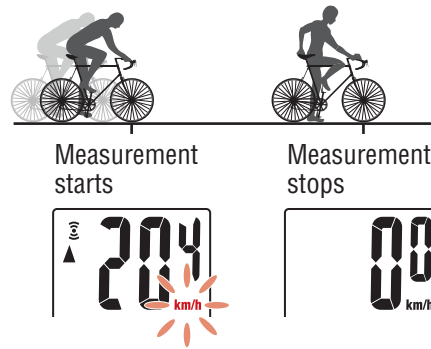

Resetting data

Pressing and holding the **MODE** button when on the measurement screen resets all measurement data to 0 (excluding **Odo**).

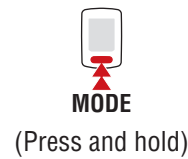

2



Backlight (night mode)

When night mode is enabled, the backlight turns on for 5 seconds when the button is pressed. Backlight operation can be extended by pressing the button again.

For details on the setting method, see "Night mode" (page 10).

* When the remaining battery charge is low (when  turns on), the backlight will not turn on.

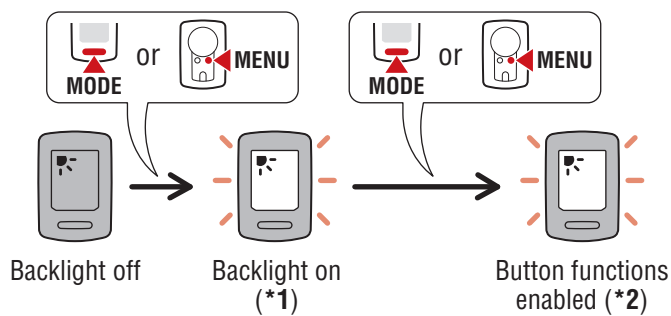

*1: When you press the button at the specified time, the backlight turns on, and the actual function of the button is not performed.

*2: If you press the button when the backlight is on, the function of the button will be performed.

3



Power-saving function

If the computer does not receive any signal for 10 minutes, the power-saving screen is activated and only the clock is displayed. If **MODE** is pressed or a sensor signal is received while the power-saving screen is activated, the computer returns to the measurement screen.

* If the computer is left on the power-saving screen for 1 hour, **SLEEP** is displayed. When the computer is in this state, you can return to the measurement screen by pressing the **MODE** button.

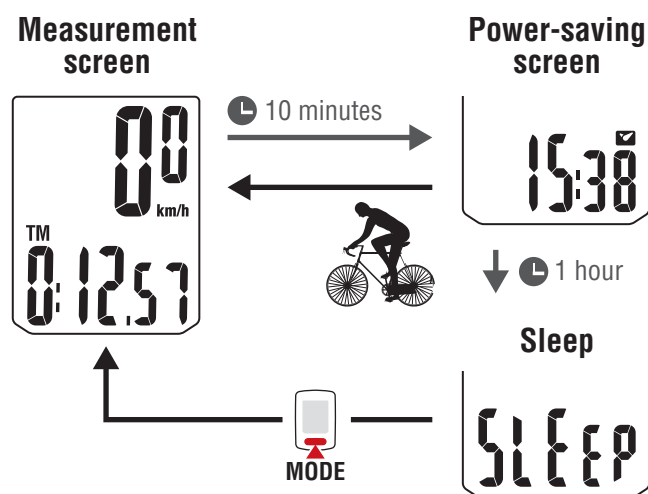

4



Appendix

Changing settings [Menu screen]



On the measurement screen, press **MENU** to go to the menu screen. Various settings can be changed on the menu screen.

- * After changing settings, always press **MENU** to confirm changes.
- * When the menu screen is left on for 1 minute, the computer returns to the measurement screen.

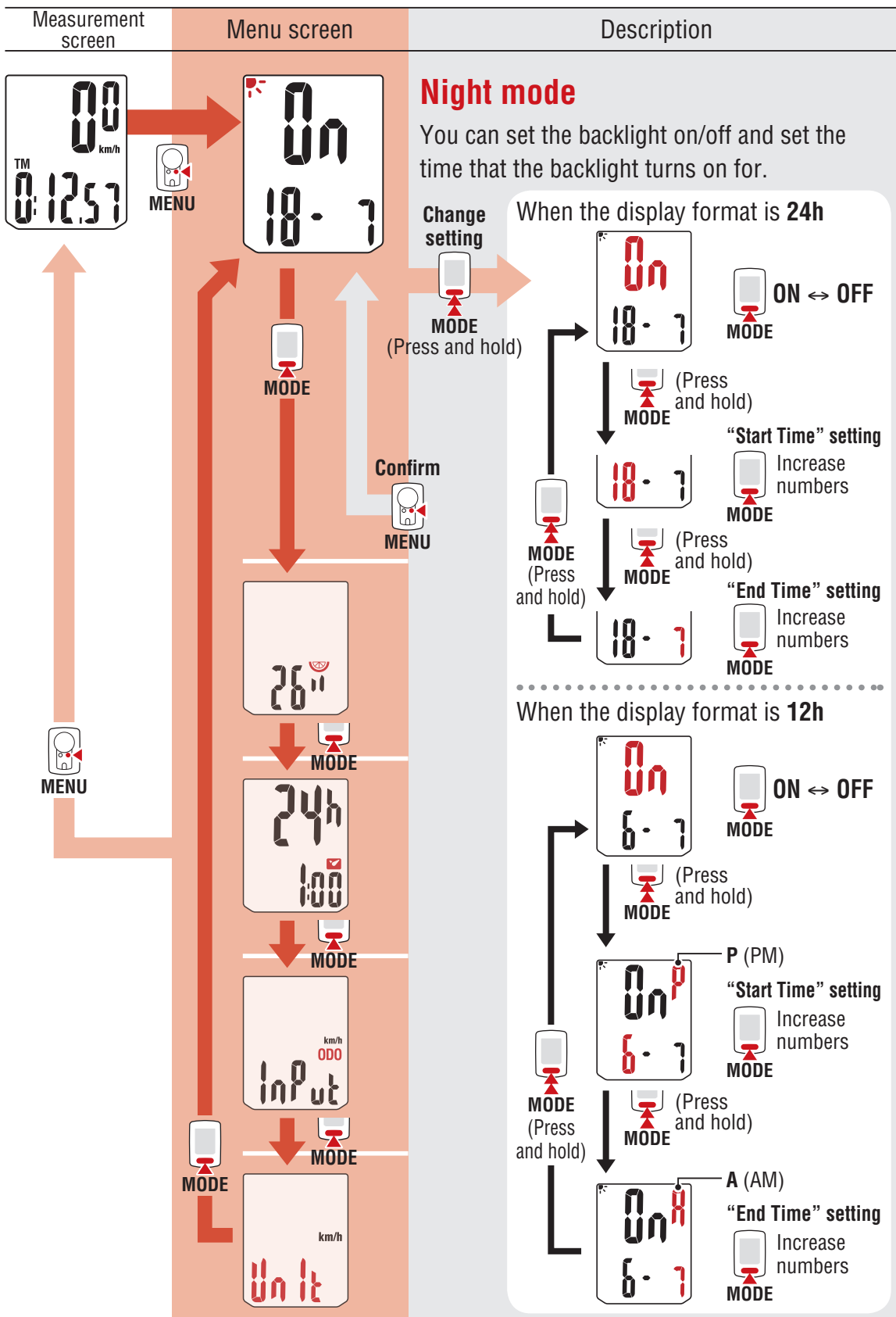

Changing settings [Menu screen]

1

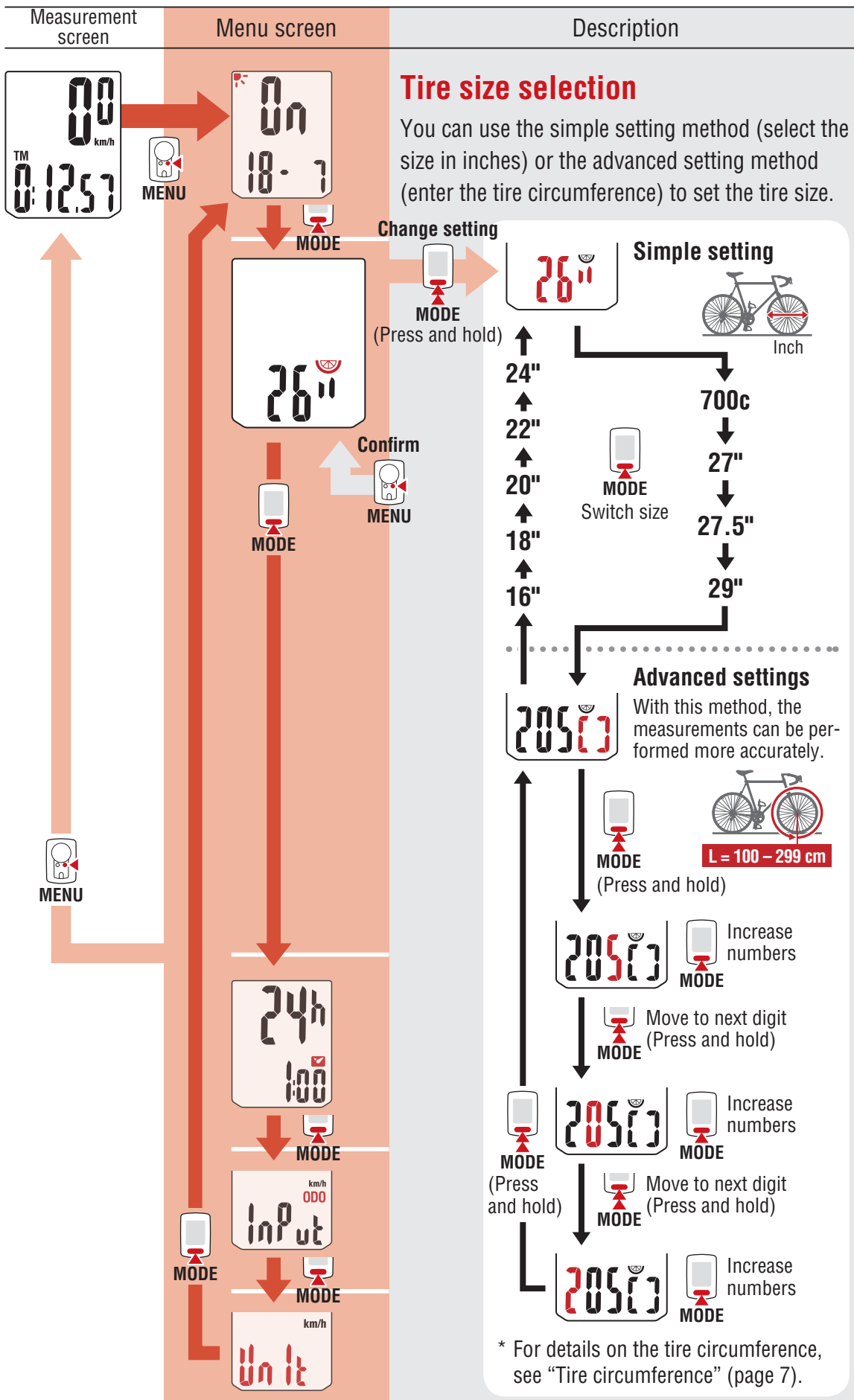

2



3



4



Appendix

Changing settings [Menu screen]

1

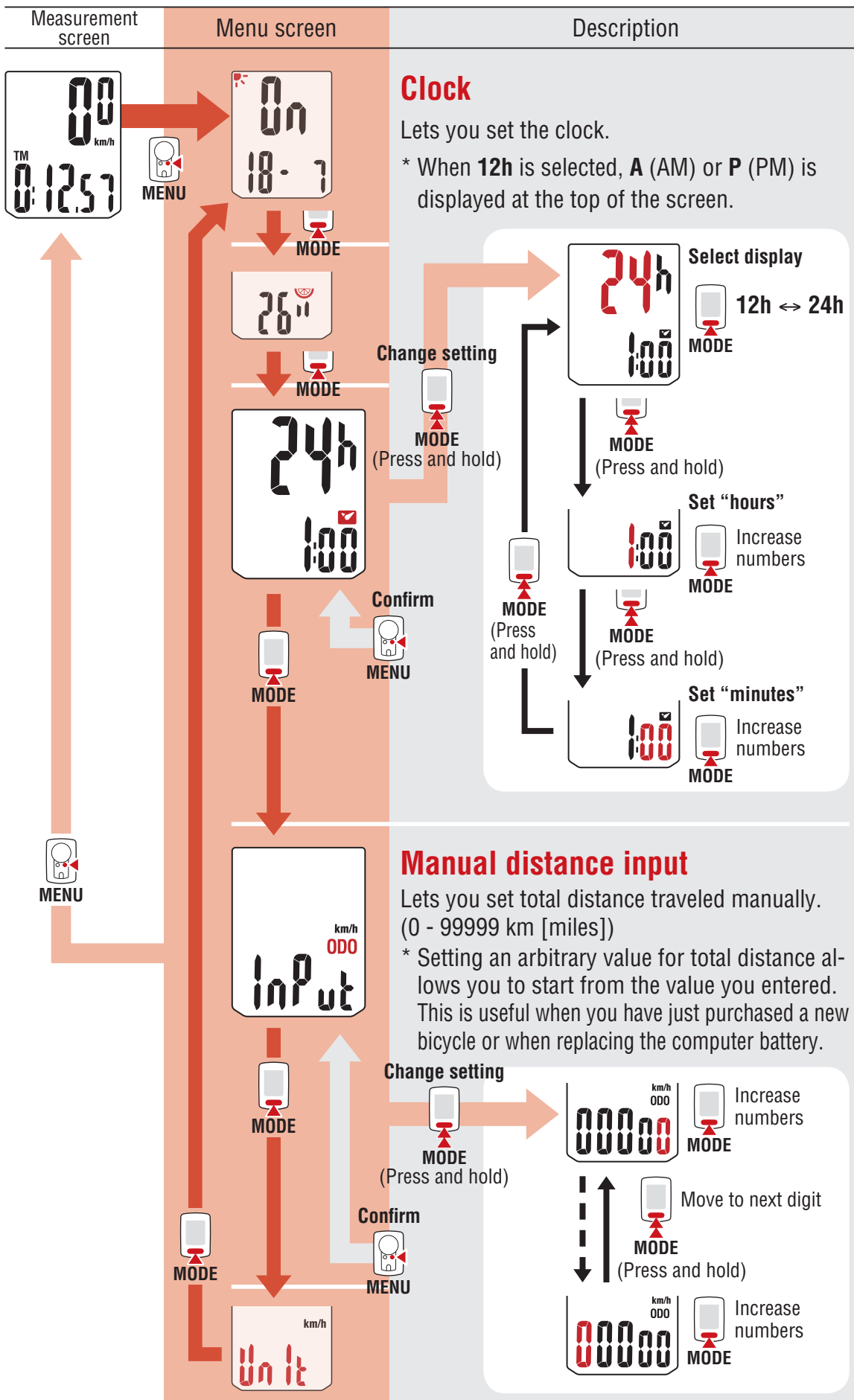

2



3



4



Appendix

Changing settings [Menu screen]

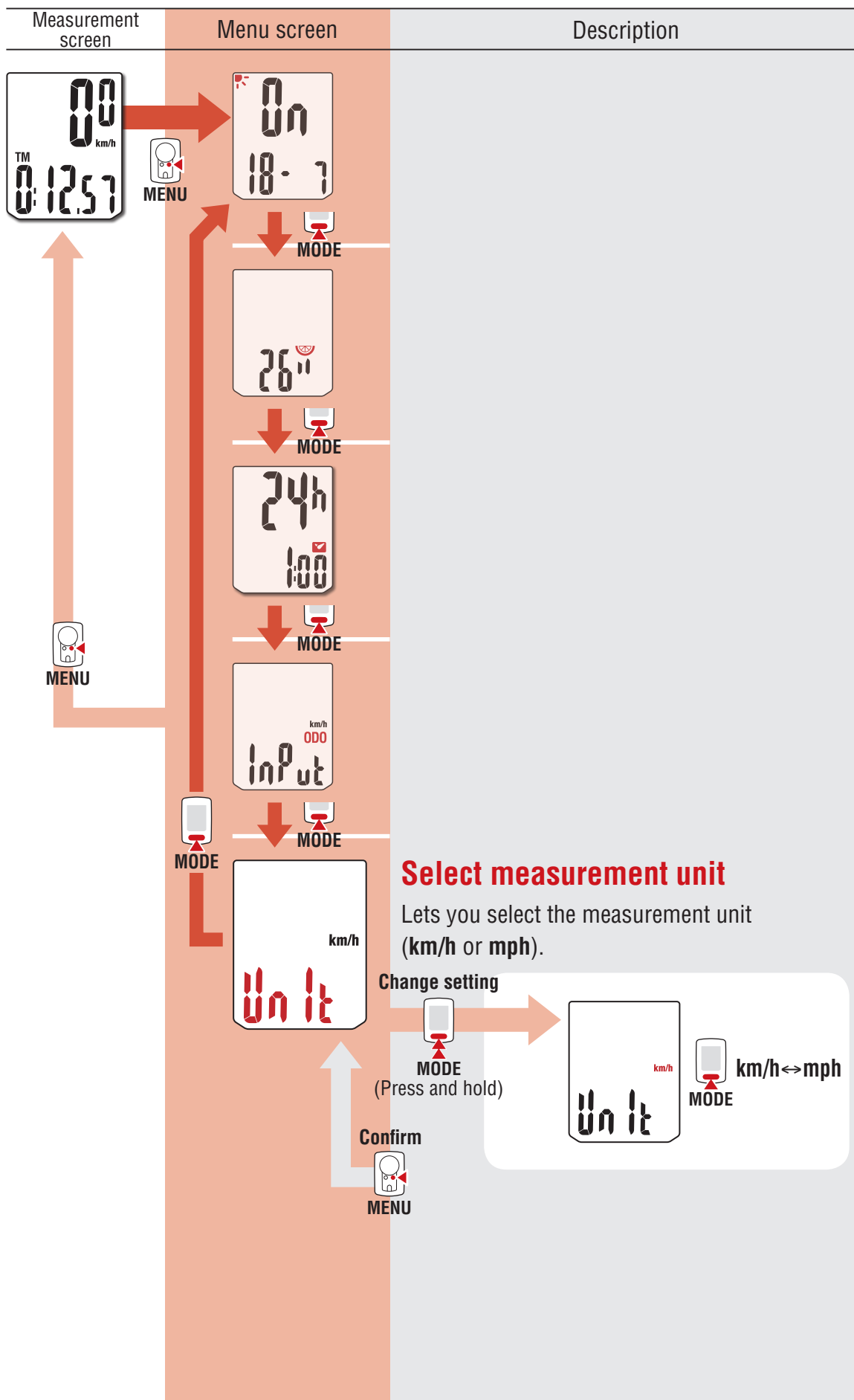

- 1
- 2
- 3
- 4
- Appendix

Appendix

Warning / Caution

- Do not concentrate on the computer while riding. Always ride safely.
- Mount the magnet, sensor, and bracket securely, and check them periodically to ensure that they are not loose.
- If a battery is swallowed accidentally, consult a doctor immediately.
- Do not leave the computer in direct sunlight for a long period of time.
- Do not disassemble the computer.
- Do not drop the computer. Doing so may result in malfunction or damage.
- When cleaning the computer and accessories, do not use thinners, benzene, or alcohol.
- Risk of explosion if battery is replaced by an incorrect type.
Dispose of used batteries according to local regulations.
- The LCD screen may be distorted when viewed through polarized sunglass lenses.

Wireless Sensor

The speed sensor is designed with a maximum signal range of 70 cm (27"), to reduce the chance of interference. (The signal range is intended to serve as a rough guide only.)

When handling the wireless sensor, note the following:

- Signals cannot be received if the distance between the speed sensor and the computer is too large.
- Signal range may be shortened due to low temperature and flat batteries.
- Signals can be received only when the back of the computer is facing the speed sensor.

Interference may occur, resulting in malfunction, if the computer is:

- Near a TV, PC, radio, or motor, or in a car or train.
- Close to a railroad crossing, railway tracks, TV transmitter station, or radar station.
- Used with other wireless devices or certain battery-powered lights.

This device complies with Part 15 of the FCC Rules. Operation is subject to the following two conditions: (1) This device may not cause harmful interference, and (2) this device must accept any interference received, including interference that may cause undesired operation.

Modifications

The FCC requires the user to be notified that any changes or modifications made to this device that are not expressly approved by CatEye Co., Ltd. may void the user's authority to operate the equipment.

Hereby, CATEYE Co., Ltd., declares that this CC-VT235W is in compliance with the essential requirements and other relevant provisions of Directive 1999/5/EC.

1



2



3



4



Appendix

Appendix

1



Maintenance

If the computer or accessories become dirty, clean with a soft cloth which is moistened with mild soap.

Replacing the battery

● Computer

When  (battery icon) is turned on, replace the battery. Insert a new lithium battery (CR2032) with the (+) side up.

- * After replacing the battery, always follow the procedure described in “Setting up the computer” (page 5).
- * If you make a note of the total distance value before replacing the battery, you will be able to continue from the same total distance by entering it after replacing the battery.

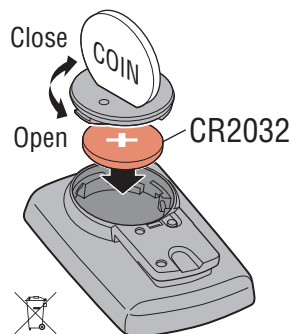

● Speed sensor

When the speed is not displayed even after adjusting correctly, it is time to replace the battery. Insert a new lithium battery (CR2032) with the (+) side up and close the battery cover firmly.

- * After replacing the battery, adjust the position of the magnet relative to the speed sensor as described in “Mounting the computer” (page 4) step 4.

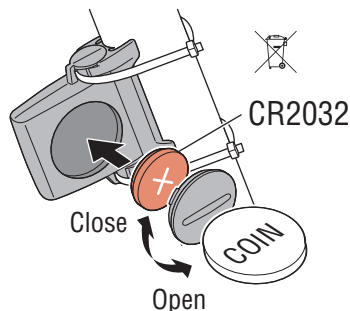

2



Troubleshooting

3



The sensor signal reception icon does not flash. (Speed is not displayed.)

- Is there too much clearance between the speed sensor and the magnet? (Clearance should be within 5 mm (3/16”).)
- Does the magnet pass through the sensor zone correctly?
Adjust the position of the magnet and/or the speed sensor.
- Is the computer mounted at the correct angle?
Ensure that the back of the computer faces the speed sensor.
- Are the computer and the speed sensor mounted at the correct distance apart? (Clearance should be from 20 to 70 cm (8” to 27”).)
Ensure that the speed sensor is within range.
- Is the computer or speed sensor battery flat?
 - * Battery performance diminishes in winter.If the computer reacts only when it is close to the speed sensor, the problem may be due to weak batteries.

Replace the batteries with new ones as described in “Replacing the battery”.

The display remains blank when the button is pressed.

Replace the computer battery as described in “Replacing the battery”.

Incorrect data appear.

Clear all according to the procedure described in “Setting up the computer” (page 5).

4



Appendix

Appendix

Main specifications

Batteries used Battery life	Computer	Lithium battery (CR2032) x1 / Approx. 1 year (If used for 1 hour a day; actual battery life will vary depending on usage conditions.)
	Speed sensor	Lithium battery (CR2032) x1 / Total distance approx. 10000 km [6,250 miles]

* Average value when used at temperature of 20 °C with computer and sensor mounted 65 cm apart.

* Life of pre-installed battery may be shorter than indicated above.

Controller	4 bit, 1-chip microcomputer (Crystal controlled oscillator)	
Display	Liquid crystal	
Sensor	Non-contact magnetic sensor	
Signal range	20 to 70 cm (8" to 27")	
Tire size to be selected	26", 700c, 27", 27.5", 29", 16", 18", 20", 22" and 24", or tire circumference of 100 cm - 299 cm (initial value: 26 inch)	
Operating temperature range	32°F – 104°F (0°C – 40°C) (Guaranteed operating temperature range: Display visibility may deteriorate outside this range.)	
Dimensions/ weight	Computer	2-3/16" x 1-29/64" x 21/32" (55.5 x 37 x 16.5 mm) / 0.93 oz (26.4 g)
	Speed sensor	1-41/64" x 1-27/64" x 19/32" (41.5 x 36 x 15 mm) / 0.53 oz (15 g)

* Specifications and design are subject to change without notice.

LIMITED WARRANTY

2-Years Computer/Speed Sensor Only

(Accessories and Battery Consumption Excluded)

CatEye cycle computers are warranted to be free of defects from materials and workmanship for a period of two years from original purchase. If the product fails to work due to normal use, CatEye will repair or replace the defect at no charge. Service must be performed by CatEye or an authorized retailer. To return the product, pack it carefully and enclose the warranty certificate (proof of purchase) with instruction for repair. Please write or type your name and address clearly on the warranty certificate. Insurance, handling and transportation charges to CatEye shall be borne by person desiring service.

For UK and REPUBLIC OF IRELAND consumers, please return to the place of purchase. This does not affect your statutory rights.

Please register your CatEye product on the website.
<http://www.cateye.com/en/support/regist/>

CAT EYE CO., LTD.

2-8-25, Kuwazu, Higashi Sumiyoshi-ku, Osaka 546-0041 Japan
Attn: CATEYE Customer Service

Phone : (06)6719-6863

Fax : (06)6719-6033

E-mail : support@cateye.co.jp

URL : <http://www.cateye.com>

[For US Customers]

CATEYE AMERICA, INC.

2825 Wilderness Place Suite 1200, Boulder CO 80301-5494 USA

Phone : 303.443.4595

Toll Free : 800.5.CATEYE

Fax : 303.473.0006

E-mail : service@cateye.com

Standard accessories

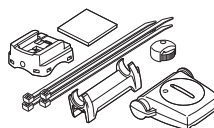

1602990
Parts kit

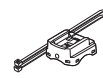

1602980
Nylon tie
bracket

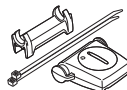

1602196
Speed sensor
(SPD-01)



1699691N
Wheel magnet



1665150
Lithium battery

Optional accessories



1604100
Out-front bracket



1602194
Bracket kit

1



2



3



4



Appendix