



VOLT400XC™

HL-EL070RC

Manual



Before using the light, read this manual thoroughly and keep it for future reference.

Design Pat. Pending
Copyright © 2017 CATEYE Co., Ltd.
HLEL070RC-170525 5



1 HOW TO CHARGE

Always charge the product before use.

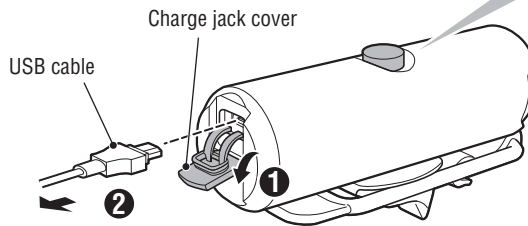

To PC or USB battery charger

Switch (Indicator)



Charging
(Illuminated in red)



Charging is completed
(Off)

Standard charging time

Approx. **6h**
(USB 2.0)

2 HOW TO MOUNT

Attach securely in the mounting position.

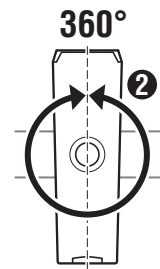
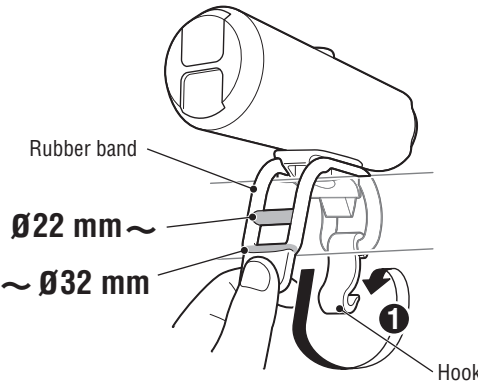

This light rotates 360 degrees to adjust angle.

3 SWITCH OPERATION

Switch (Indicator)

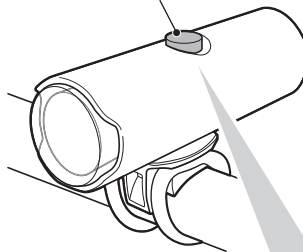

Press and hold



Double-click



Click

LITHIUM-ION BATTERIES

Cautions on recharging

- We recommend using 500+mA (USB2.0) USB battery charger.
- Avoid charging in direct sunlight or in a vehicle parked under direct sunlight, and make sure to charge only when the ambient temperature is between 41°F and 104 °F (5 and 40°C).
- Before charging, be sure that no dust or other foreign objects attach to the USB plug.
- Do not subject the light to vibrations while charging.
- When your PC is in sleep state, the unit cannot be charged.
- Once charging is complete, be sure to disconnect the USB plug.
- Charging and lighting times are approximate values, and will vary by environmental and user conditions.

Cautions in use

- Charging, discharging, and storing in high temperatures will cause the rechargeable battery to deteriorate faster. Do not place the light inside a vehicle or near a heater.
- If the illumination time is significantly reduced even after proper charging, the rechargeable battery may be nearing the end of its service life. Dispose of the battery as described in "PRECAUTIONS ON DISPOSAL".

Cautions on storage

Cool and dry storage is recommended. For long period storage, it is important to charge the battery 30 minutes every 6 months.

Cautions for dispose

When disposing of the light unit, remove the internal rechargeable battery and dispose of it according to local regulations.

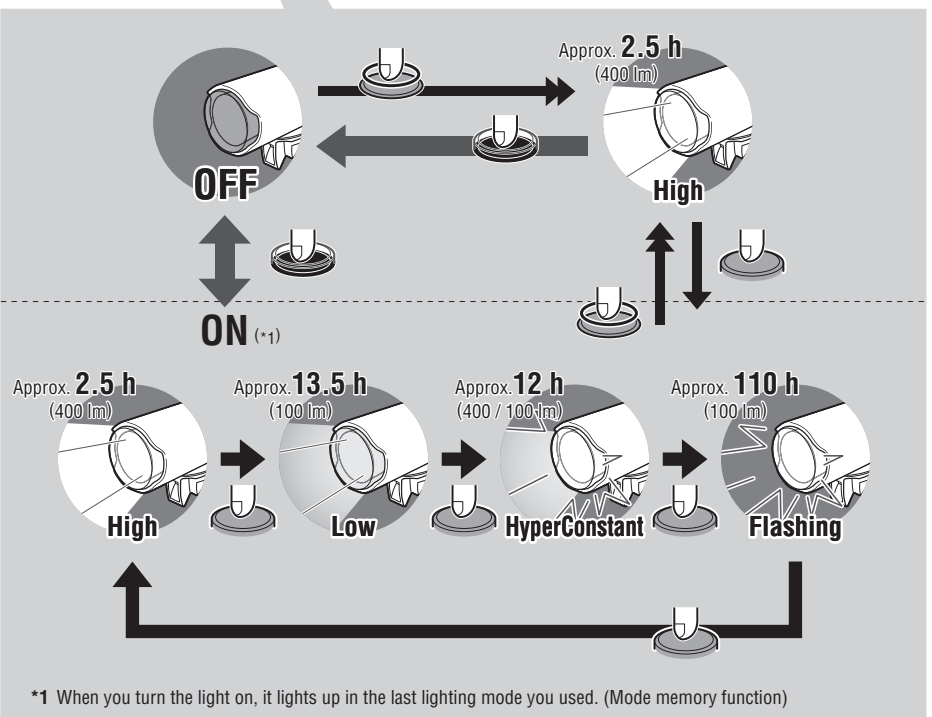

*1 When you turn the light on, it lights up in the last lighting mode you used. (Mode memory function)

* When the switch (indicator) lights up, the remaining battery power is 20% or less. Please charge as soon as possible.

SPARE / OPTIONAL PARTS

5342730

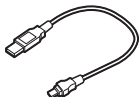

USB cable
(MICRO USB)

5441621

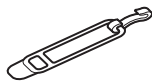

Rubber band and hook

5342990

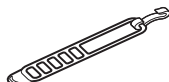

Rubber band and hook
(LONG)

SPECIFICATIONS

Battery : Rechargeable lithium-ion battery (2200 mAh)
Temperature range : 14°F – 104°F (-10°C – 40°C)
Recharge/discharge number of times : About 300 times (until the rated capacity drops to 70%)
Dimensions/weight : 3-21/32" x 1-13/64" x 1-37/64"
(93 x 30.5 x 40 mm) / 3.35 oz (95 g)

* The specifications and design are subject to change without notice.

LIMITED WARRANTY

2-year Warranty: Light unit only (excludes battery deterioration)

CatEye products are warranted to be free of defects from materials and workmanship for a period of 2 years from original purchase. If the product fails to work during normal use, CatEye will repair or replace the defect at no charge. Service must be performed by CatEye or an authorized retailer. To return the product, pack it carefully and enclose the warranty certificate (proof of purchase) with instruction for repair. Please write or type your name and address clearly on the warranty certificate. Insurance, handling and transportation charges to CatEye shall be borne by person desiring service.

For UK and REPUBLIC OF IRELAND consumers, please return to the place of purchase. This does not affect your statutory rights.

Please register your CatEye product on the website.
<http://www.cateye.com/en/support/regist/>

CATEYE CO., LTD.

2-8-25, Kuwazu, Higashi Sumiyoshi-ku,
Osaka 546-0041 Japan
Attn: CATEYE Customer Service
Section
Phone : (06)6719-6863
Fax : (06)6719-6033
E-mail : support@cateye.co.jp
URL : <http://www.cateye.com>

[For US Customers]
CATEYE AMERICA, INC.
2825 Wilderness Place Suite 1200,
Boulder CO 80301-5494 USA
Phone : 303.443.4595
Toll Free : 800.5.CATEYE
Fax : 303.473.0006
E-mail : service@cateye.com