



# CATEYE PADRONE DIGITAL



CYCLOCOMPUTER  
CC-PA400B



- This instruction manual is subject to change without notice. See our website for the latest instruction manual (PDF).
- Please visit our website, where a detailed Quick Start manual containing videos can be downloaded.

<http://www.cateye.com/products/detail/CC-PA400B/manual/>



The Bluetooth® word mark and logos are owned by the Bluetooth SIG, Inc. and any use of such marks by CATEYE Co., Ltd. is under license. Other trademarks and trade names are those of their respective owners.

Introduction

Cover,  
Introduction

Mounting  
the PADRONE DIGITAL  
Wearing  
the heart rate sensor



1

Setting up the  
PADRONE DIGITAL



2

- ▶ PADRONE DIGITAL
- ▶ Smartphone

Using the unit

Using the app

Starting measurement



3

Changing settings



4

Capabilities with a smart-  
phone (Cateye Cycling™)



5

Warning / Caution  
Product Warranty, etc.

Appendix

# Introduction

The PADRONE DIGITAL is a cyclocomputer that uses Bluetooth® SMART sensors. In addition to the included sensors, optional or commercial sensors can also be connected for use.

## Mounting the PADRONE DIGITAL, Wearing the heart rate sensor

### If you have purchased the double wireless kit

The model you have purchased does not come with the heart rate sensor and HR strap. You can use all the functions written in this instruction manual, such as measurements related to your heart rate, by using an optional heart rate sensor kit.

- [Mount the bracket \(Page 3\)](#)
- [Mounting the speed/cadence sensor \(ISC-12\) \(Page 5\)](#)
- [Wearing the heart rate sensor \(HR-12\) \(Page 9\)](#)

\* For detailed explanations on how to use CATEYE sensors such as mounting, or pairing, see [the sensor's Online Manual](#) (on our website) or the [Quick Start Manual](#) (PDF/smartphone app).

## Setting up the PADRONE DIGITAL

**The first time that you use this product, perform the initial setup from the PADRONE DIGITAL or from a smartphone (Cateye Cycling™).**

Use the method corresponding to your device to set up the PADRONE DIGITAL. You can change the display of its measurement screen and its total distance value as necessary.

\* If you have a smartphone, you can use the “Cateye Cycling™” smartphone app (free of charge) to easily set up the PADRONE DIGITAL.

- If you do not have a smartphone
  - [1. Setup with the PADRONE DIGITAL \(Page 11\)](#)
  - [2. Changing settings \(Page 22\)](#)
- If you have a smartphone
  - [1. Setup with a smartphone \(Cateye Cycling™\) \(Page 15\)](#)
  - [2. Capabilities with a smartphone \(Page 31\)](#)



1



2

Using the unit

Using the app



3



4



5

# Mounting the PADRONE DIGITAL

## Mount the bracket

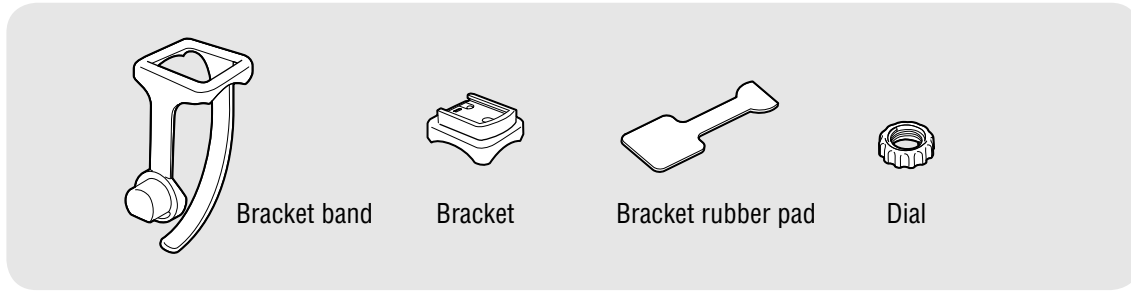

1  
1/8

The bracket can be mounted on either the stem or the handlebar.

### 1 Mount the bracket

- When mounting on stem

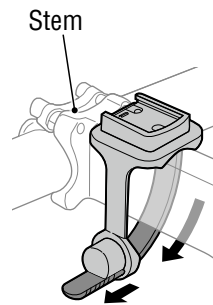
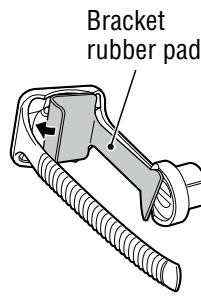
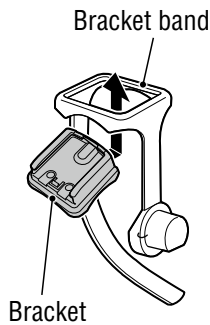
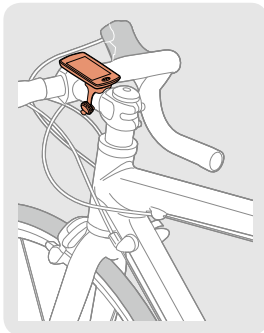

- When mounting on handlebar

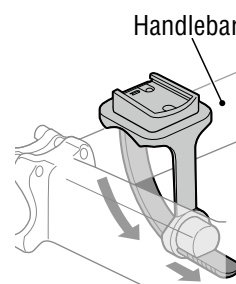
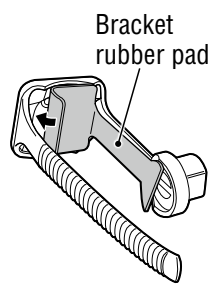
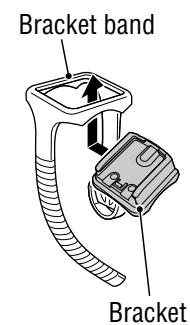
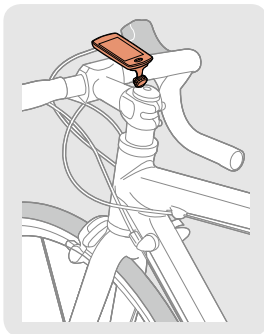

Cutting band after mounting

**⚠ Caution!**

Cut the bracket band so that cut end will not cause injury.

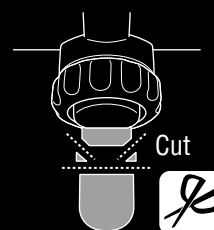
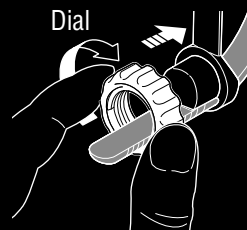

2

Using the unit

Using the app



3



4



5

Mount the bracket

2 Attach/detach PADRONE DIGITAL

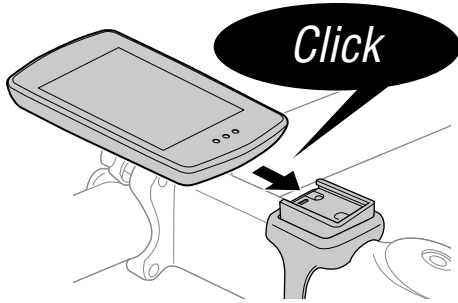

Hold PADRONE DIGITAL.

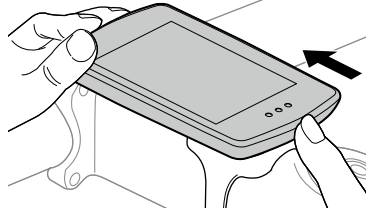

Push out so that front lifts up.



1  
2/8



2

Using the unit

Using the app



3



4



5

## Mounting the speed/cadence sensor (ISC-12)

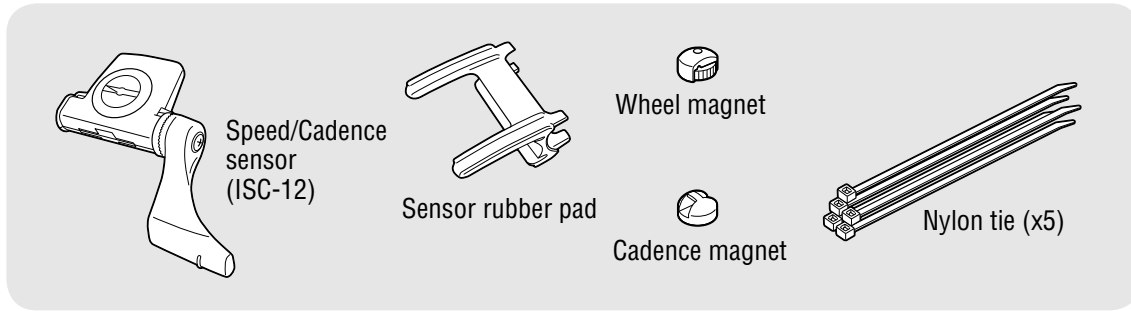

The speed (cadence) sensor can be mounted either on the top or bottom of the chain stay.

- Mounting on top of chain stay
- Mounting on bottom of chain stay

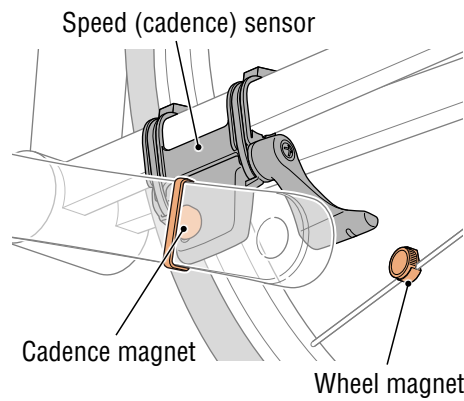
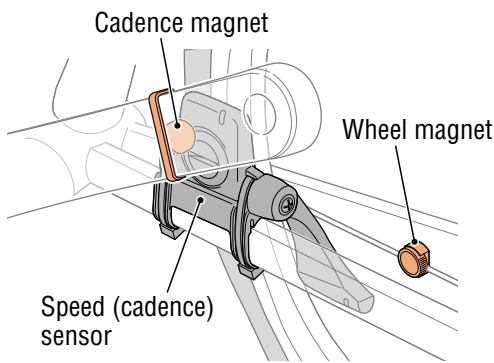

**⚠ Caution!:**

**If the speed (cadence) sensor is mounted on the bottom of the chain stay rather than on the top, the adjustment range between the sensor and the magnet will be narrower.**

\* If using pedals with steel axles, the cadence magnet can be attached magnetically to the pedal axle.

\* For detailed explanations on how to use CATEYE sensors such as mounting, or pairing, see [the sensor's Online Manual](#) (on our website) or the [Quick Start Manual](#) (PDF/ smartphone app).

\* The following mounting procedure gives instructions for mounting on the top of the chain stay.



1  
3/8



2

Using the unit

Using the app



3



4



5

## Mounting the speed/cadence sensor (ISC-12)

### 1 Temporarily attach the sensor to the left chain stay.

- (1) Loosen the sensor screw using a Phillips screwdriver and check that the sensor arm moves.

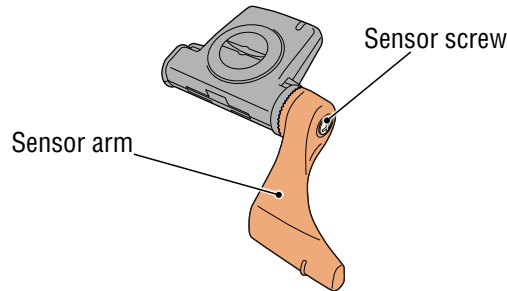

- (2) Attach the sensor rubber pad to the sensor.

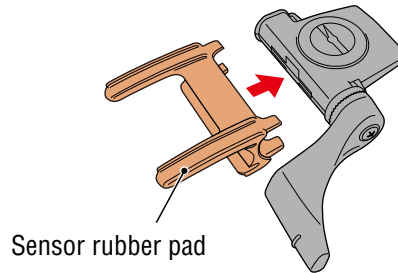

- (3) Refer to the illustration and temporarily attach the sensor to the left chain stay with nylon ties.

**⚠ Caution!:**

**Do not fully tighten the nylon ties.**

**Once the nylon ties are fully tightened they cannot be removed.**

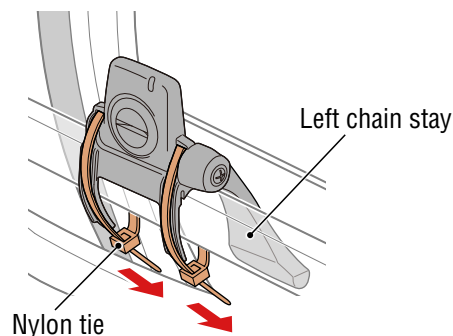

1  
4/8



2

Using the unit

Using the app



3



4



5

## Mounting the speed/cadence sensor (ISC-12)

### 2 Temporarily attach the magnet.

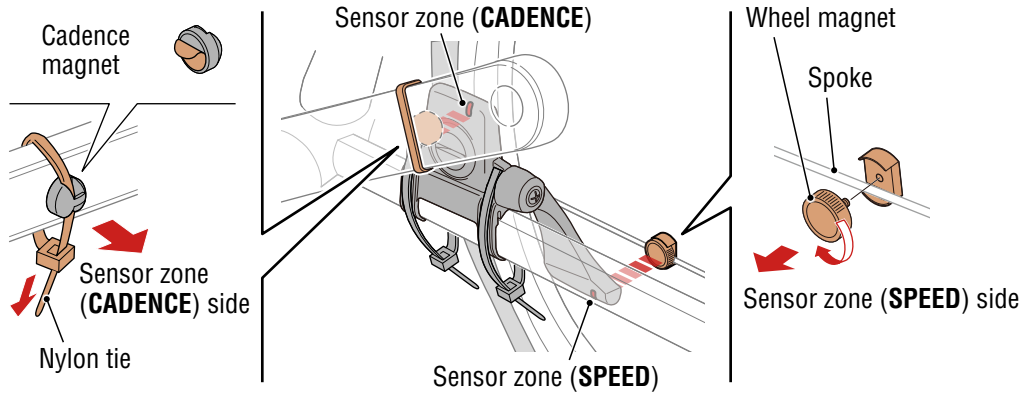

- (1) Using a nylon tie, temporarily attach the cadence magnet to the inside of the left crank arm so that it faces the cadence sensor zone.
  - \* If using pedals with steel axles, the cadence magnet can be attached magnetically to the pedal axle. In this case, remove the adhesive tape from the magnet and do not use the nylon tie.
- (2) Rotate the sensor arm and temporarily attach the wheel magnet to a spoke facing the speed sensor zone.
  - \* Reposition the sensor and the magnets if both magnets (speed and cadence) cannot pass through their respective sensor zones.

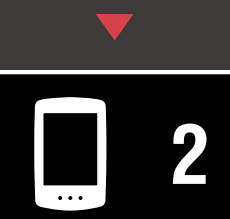
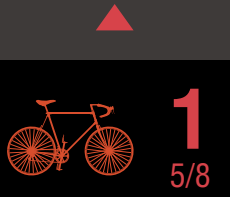

Using the unit

Using the app



## Mounting the speed/cadence sensor (ISC-12)

### 3 Adjust the gap between the sensor zone and the magnet.

- (1) Tilt the sensor so that the gap between the cadence magnet and the cadence sensor zone is approximately 3 mm, then fasten the sensor securely with nylon ties.

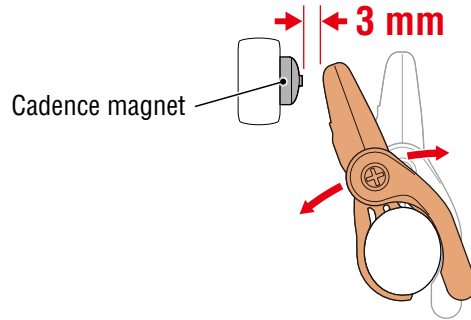

- (2) Rotate the sensor arm so that the gap between the wheel magnet and the speed sensor zone is approximately 3 mm, then tighten the sensor screw securely.

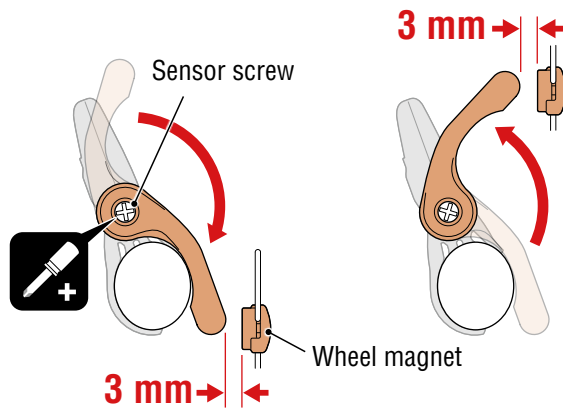

### 4 Secure all parts.

Securely tighten the sensor's nylon ties, the sensor screw, the wheel magnet, and the cadence magnet so that they do not move, and then check that these items are not loose.

Trim off the excess nylon tie.

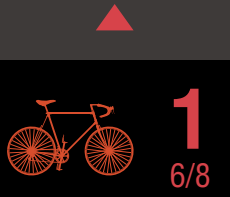

Using the unit

Using the app





# Wearing the heart rate sensor (HR-12)

Heart rate is measured by wearing a heart rate sensor around the chest.

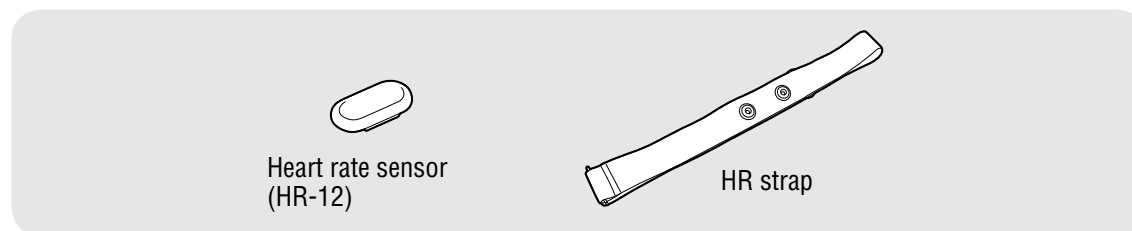

\* The double wireless kit does not include a heart rate sensor. Purchase this item separately.

## Before wearing the heart rate sensor

### **⚠ Warning!!!:**

**Never use this device if you use a pacemaker.**

- To eliminate measurement errors, it is recommended to moisten the electrode pads with water or apply electrolyte cream to the pads.
- If you have sensitive skin, moisten the electrode pads with water and wear it over a thin shirt.
- Chest hair may interfere with measurement in some cases.

\* For detailed explanations on how to use CATEYE sensors such as mounting, or pairing, see [the sensor's Online Manual](#) (on our website) or the [Quick Start Manual](#) (PDF/ smartphone app).

## 1 Attach the sensor to the HR strap.

Press until you hear a clicking sound.

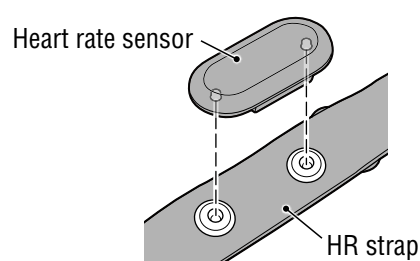

1  
7/8



2

Using the unit

Using the app



3



4



5

**2** Wear the HR strap by sliding the hook over the other end of the strap.

Wind the HR strap around your body and adjust the length to suit your chest (underbust). Overtightening the strap may cause discomfort during measurement.

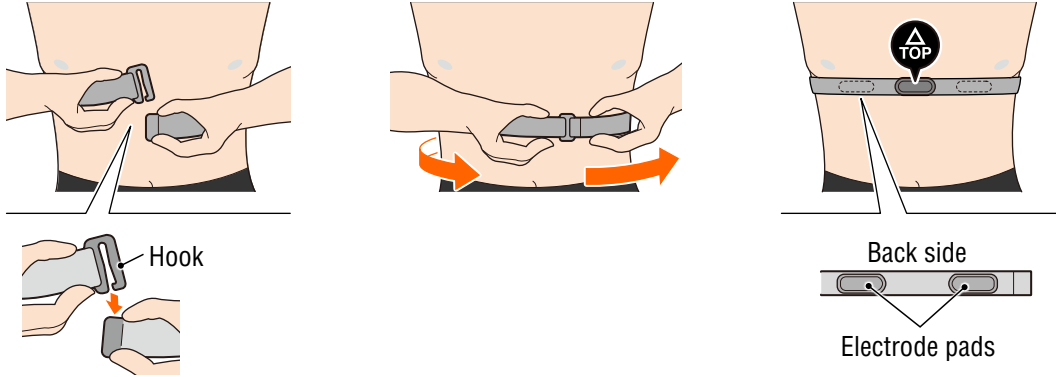

- \* Wear the heart rate sensor so that **TOP** faces up.
- \* Ensure that the electrode pads are in close contact with your body.
- \* If you have dry skin or are wearing the sensor over a shirt, measurement errors may result. In such cases, moisten the electrode pads with water.



Using the unit

Using the app



# Setting up the PADRONE DIGITAL

## Setup with the PADRONE DIGITAL

\* Check the locations of the buttons on the PADRONE DIGITAL before starting setup.

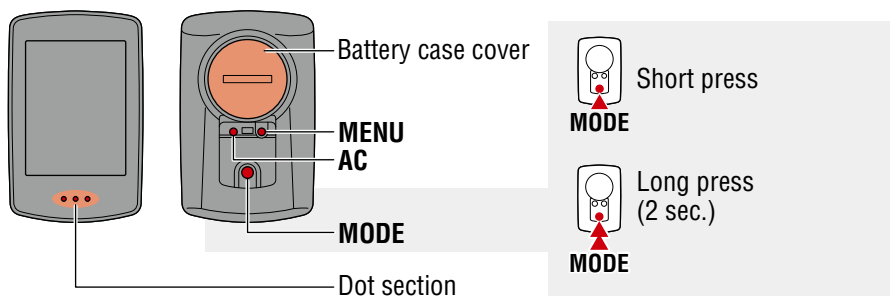

### 1 Format (initialize) the unit.

While holding down **MENU** on the back of the PADRONE DIGITAL, press and release the **AC** button.

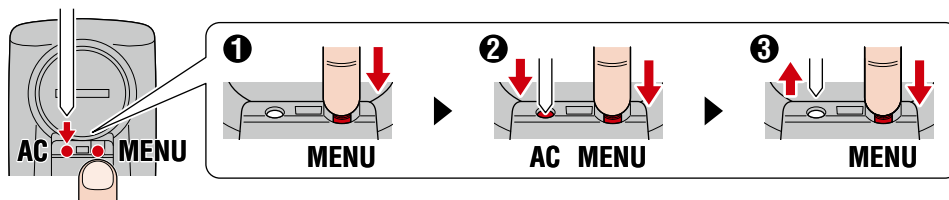

The whole display turns on, and then the smartphone search screen is displayed.

\* All data is deleted and the unit is reset to the factory default settings.

\* If the smartphone search screen is not displayed, the unit could not be formatted. Try to perform the operation again.

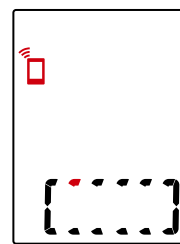

### 2 Select the measurement unit.

Press **MODE** to select "km/h" or "mph".  
After selecting a value, press **MENU** to proceed to the next step.

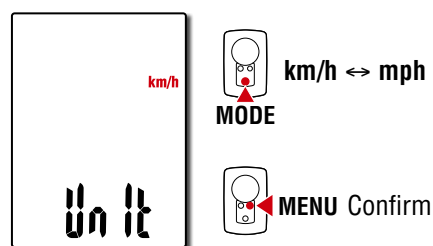

## Setup with the PADRONE DIGITAL

### 3 Pair with a sensor.

**⚠ Caution!:**

- To use the PADRONE DIGITAL, you have to pair it with a sensor that supports the Bluetooth® SMART standard.
- Avoid pairing sensors at a race venue or in similar locations where there are a lot of other users. Doing so may cause the PADRONE DIGITAL to be paired with another device.

The unit switches to the pairing standby screen and **Pr** flashes on the screen.

Use one of the methods in the following table to activate the sensor.



CATEYE sensors	Activating the sensor	Display
Speed/Cadence sensor	Move the magnet through the sensor zone several times. (Within 3 mm)	ISC
Heart rate sensor	Rub both electrode pads with your thumbs.	Hr

\* With the speed/cadence sensor and heart rate sensor, you can also activate the sensor by pressing the **RESET** button.

Once pairing is complete, the name of the sensor is shown in the upper display.

\* When pairing a sensor with the PADRONE DIGITAL, a “C” is displayed after the sensor name.

### 4 To pair multiple sensors, hold down **MODE** to return to the pairing standby screen.

Repeat step 3 to pair all the sensors that you intend to use. Once you are finished pairing sensors with the unit, press **MENU** to proceed to the next step.

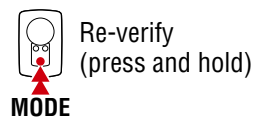

## Setup with the PADRONE DIGITAL

### 5 Set tire circumference.

Enter the tire circumference (the length of the outer circumference of the tire) in mm for the tire on which the sensor is installed.  
(100 to 3999 mm)

\* Refer to [“Tire circumference table” \(Page 14\)](#)

\* In the setup of the PADRONE DIGITAL, sensors capable of speed measurement are set to the same tire circumference value.

To change the tire circumference for each sensor, see the menu screen,

[“Tire circumference” \(Page 24\)](#), after completing setup.

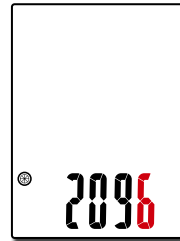

Increase numbers

Move to next digit (Press and hold)

**MENU** Confirm

After entering a value, press **MENU** to proceed to the next step.

### 6 Set the clock.

Each time **MODE** is pressed and held, settings switch from time display mode, to hours, to minutes.

\* When **12h** is selected, press **MODE** to select **A** (a.m.) or **P** (p.m.).

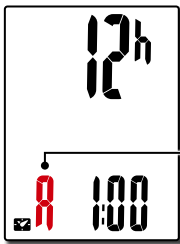

**A** (a.m.)  
 **P** (p.m.)

Time display mode

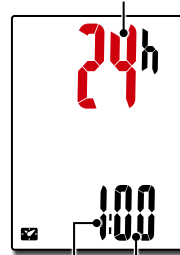

Hours Minutes

Switch between **24h** and **12h** or increase numbers

Switch setting item (Press and hold)

### 7 Press **MENU** to complete setup.

Setup is completed and the PADRONE DIGITAL switches to the measurement screen.

For instructions on how to start measurement, refer to [“Starting measurement” \(Page 19\)](#).

**MENU**  
Setup complete



1



2  
Unit  
3/4



3



4



5

## Setup with the PADRONE DIGITAL

### Tire circumference table

Tire circumference can be determined by either of the following two methods:

- Measure the actual tire circumference (L)  
After ensuring that the tire pressure is appropriate, sit on your bike, roll it forward so that the tire makes one full revolution (use the valve or other marking as a reference), and measure the distance traveled on the road.

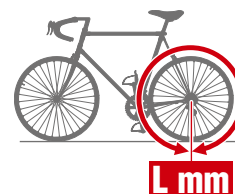

- Tire size chart

\* The tire size or ETRTO code is indicated on the side of the tire.

ETRTO	Tire size	L (mm)
47-203	12x1.75	935
54-203	12x1.95	940
40-254	14x1.50	1020
47-254	14x1.75	1055
40-305	16x1.50	1185
47-305	16x1.75	1195
54-305	16x2.00	1245
28-349	16x1-1/8	1290
37-349	16x1-3/8	1300
32-369	17x1-1/4 (369)	1340
40-355	18x1.50	1340
47-355	18x1.75	1350
32-406	20x1.25	1450
35-406	20x1.35	1460
40-406	20x1.50	1490
47-406	20x1.75	1515
50-406	20x1.95	1565
28-451	20x1-1/8	1545
37-451	20x1-3/8	1615
37-501	22x1-3/8	1770
40-501	22x1-1/2	1785
47-507	24x1.75	1890
50-507	24x2.00	1925
54-507	24x2.125	1965
25-520	24x1(520)	1753
	24x3/4 Tubular	1785
28-540	24x1-1/8	1795
32-540	24x1-1/4	1905
25-559	26x1(559)	1913
32-559	26x1.25	1950
37-559	26x1.40	2005
40-559	26x1.50	2010
47-559	26x1.75	2023
50-559	26x1.95	2050
54-559	26x2.10	2068
57-559	26x2.125	2070
58-559	26x2.35	2083

ETRTO	Tire size	L (mm)
75-559	26x3.00	2170
28-590	26x1-1/8	1970
37-590	26x1-3/8	2068
37-584	26x1-1/2	2100
	650C Tubular 26x7/8	1920
20-571	650x20C	1938
23-571	650x23C	1944
25-571	650x25C 26x1(571)	1952
40-590	650x38A	2125
40-584	650x38B	2105
25-630	27x1(630)	2145
28-630	27x1-1/8	2155
32-630	27x1-1/4	2161
37-630	27x1-3/8	2169
40-584	27.5x1.50	2079
50-584	27.5x1.95	2090
54-584	27.5x2.1	2148
57-584	27.5x2.25	2182
18-622	700x18C	2070
19-622	700x19C	2080
20-622	700x20C	2086
<b>23-622</b>	<b>700x23C</b>	<b>2096</b>
25-622	700x25C	2105
28-622	700x28C	2136
30-622	700x30C	2146
32-622	700x32C	2155
	700C Tubular	2130
35-622	700x35C	2168
38-622	700x38C	2180
40-622	700x40C	2200
42-622	700x42C	2224
44-622	700x44C	2235
45-622	700x45C	2242
47-622	700x47C	2268
54-622	29x2.1	2288
56-622	29x2.2	2298
60-622	29x2.3	2326



1



2  
Unit  
4/4



3



4



5

## Setup with a smartphone (Cateye Cycling™)

You can use the smartphone app “Cateye Cycling™” (free of charge) for setup.

- \* See [Cateye Cycling Recommended Devices](#) for the latest information about smartphones recommended for use with Cateye Cycling™.
- \* Check the locations of the buttons on the PADRONE DIGITAL before starting setup.

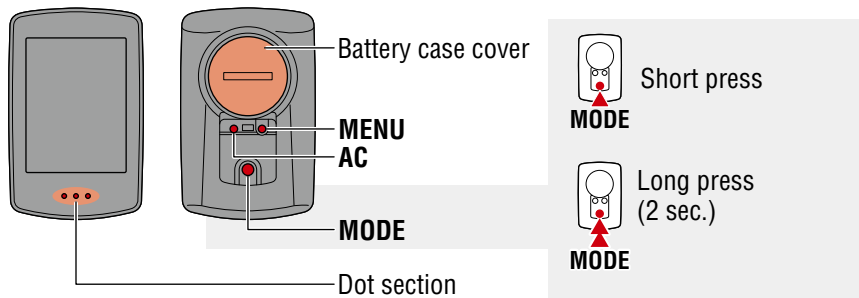

### Smartphone

## 1 Install Cateye Cycling™ on your smartphone.



## 2 Launch Cateye Cycling™.

Follow the on-screen instructions and allow the use of GPS and Bluetooth® devices.

- \* At the moment you turn on the Bluetooth® in the smartphone setting, the smartphone OS will search for devices, but do not configure settings there. Switch to Cateye Cycling™ and follow the procedure below.



Setup with a smartphone (Cateye Cycling™)

PADRONE DIGITAL

**3** Format (initialize) the unit.

While holding down **MENU** on the back of the PADRONE DIGITAL, press and release the **AC** button.

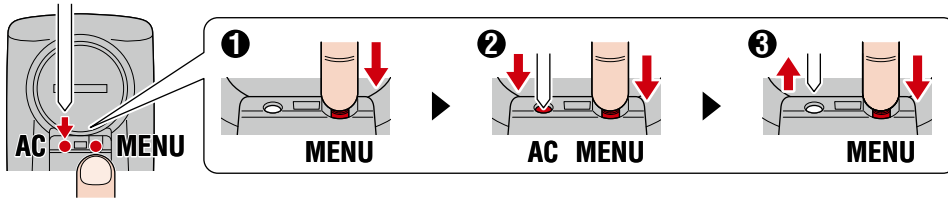

The whole display turns on, and then the smartphone search screen is displayed.

- \* All data is deleted and the unit is reset to the factory default settings.
- \* If the smartphone search screen is not displayed, the unit could not be formatted. Try to perform the operation again.

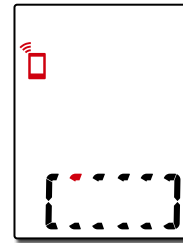

Smartphone

**4** Tap (Menu) at the top left of the screen, turn on [Connect] and tap [Device].

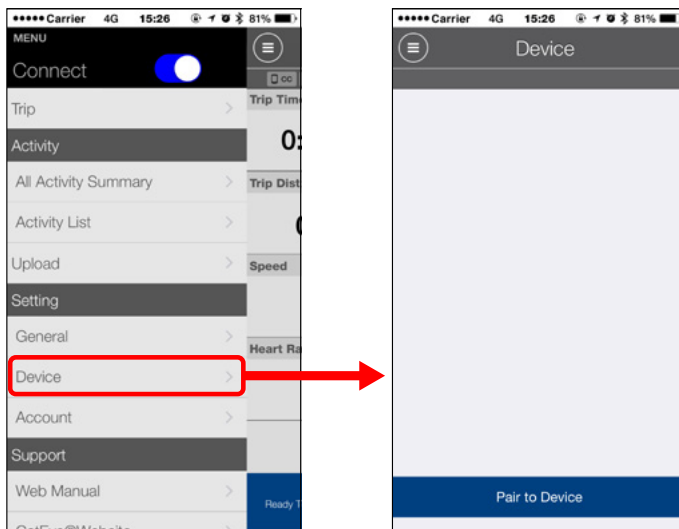



## Setup with a smartphone (Cateye Cycling™)

### 5 Tap [Pair to Device] to start the pairing of the PADRONE DIGITAL and Cateye Cycling™.

When Cateye Cycling™ detects PADRONE DIGITAL, a message is displayed on the smartphone.

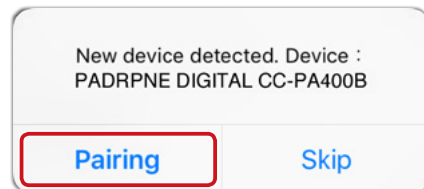

Tap [Pairing] to complete pairing.

\* The clock of the PADRONE DIGITAL is synchronized with your smartphone when you connect these devices. There is no need to set the clock from the PADRONE DIGITAL.

### 6 Tap [Pair to Device] once again to start the pairing of the sensor and Cateye Cycling™.

#### ⚠ Caution!:

- To use the PADRONE DIGITAL, you have to pair it with a sensor that supports the Bluetooth® SMART standard.
- Avoid pairing sensors at a race venue or in similar locations where there are a lot of other users. Doing so may cause the PADRONE DIGITAL to be paired with another device.
- **Pairing of a commercial sensor and the PADRONE DIGITAL:**  
If you are an iPhone user, complete the setup with Cateye Cycling™, and then separately pair the commercial sensor with the PADRONE DIGITAL. ["Pairing" \(Page 25\)](#)

\* When using an iPhone, you cannot sync settings of commercial sensors with the PADRONE DIGITAL.



## Setup with a smartphone (Cateye Cycling™)

### 7 Activate the sensor.

Use one of the methods in the following table to activate the sensor.

CATEYE sensors	Activating the sensor	Display
Speed/Cadence sensor	Move the magnet through the sensor zone several times. (Within 3 mm)	ISC
Heart rate sensor	Rub both electrode pads with your thumbs.	HR

\* With the speed/cadence sensor and heart rate sensor, you can also activate the sensor by pressing the **RESET** button.

When Cateye Cycling™ detects the sensor signal, a message is displayed on the smartphone.

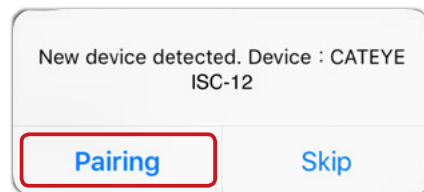

Tap [Pairing]. The paired sensor is displayed under [Device] and pairing is completed.

\* When pairing a sensor with Cateye Cycling™, an “A” is displayed after the sensor name.

### 8 To pair multiple sensors, repeat the procedure from step 6. Pair all sensors that you intend to use.

### 9 Set the tire circumference for a sensor capable of speed measurement.

Tap [Sensor name] displayed under [Device], and then tap [Tire Circumference] (the outer circumference of the tire) to select the tire circumference according to the tire size written on the side of the tire.

\* Default value: 2096 mm (700x23c)

\* The tire circumference must be set for each sensor.

### 10 If necessary, you can change the display of the PADRONE DIGITAL’s measurement screen and its total distance value.

For details, see [“Capabilities with a smartphone” \(Page 31\)](#)

### 11 Tap (Menu) at the top left of the screen, set [Connect] to OFF. The PADRONE DIGITAL disconnects from the smartphone and switches to a measurement screen to which the setup details have been applied.



1



2  
App  
4/4



3



4



5

# Starting measurement [Measurement screen]

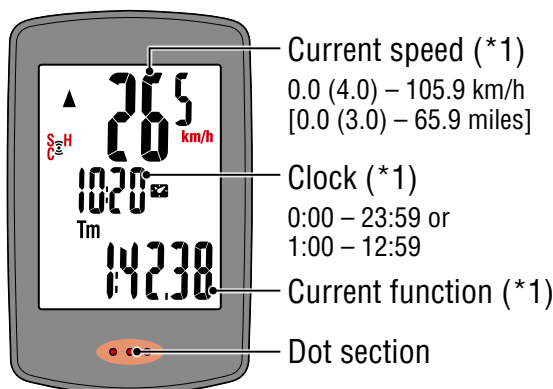

\*1: You can use the menu screen or the smartphone (Cateye Cycling™) to change the upper and middle displays and to change the selected function in the lower display.

- [Changing settings \(Page 22\)](#)
- [Capabilities with a smartphone \(Page 31\)](#)



Using the unit

Using the app



Icon	Description
	<p><b>Sensor signal icon</b> Flashes when a sensor signal is received.</p> <ul style="list-style-type: none"> <li>● <b>S:</b> Speed signal</li> <li>● <b>C:</b> Cadence signal</li> <li>● <b>H:</b> Heart rate signal</li> </ul>
	<p><b>Pace arrows</b> Indicates whether the current speed is faster (▲) or slower (▼) than the average speed.</p>
	<p><b>Memory alarm</b> This is displayed when the amount of remaining memory on the PADRONE DIGITAL is low. While this icon is displayed, the oldest files will be deleted in order to make room for new measurements.</p>



 **MENU**

On the measurement screen, press **MENU** to go to the menu screen. Various settings can be changed on the menu screen.

\* If you are using a smartphone, you can easily configure PADRONE DIGITAL settings from the smartphone.  
For details, see [“Capabilities with a smartphone” \(Page 31\)](#).

## Switching current function

Pressing **MODE** switches the current function displayed at the bottom of the screen.

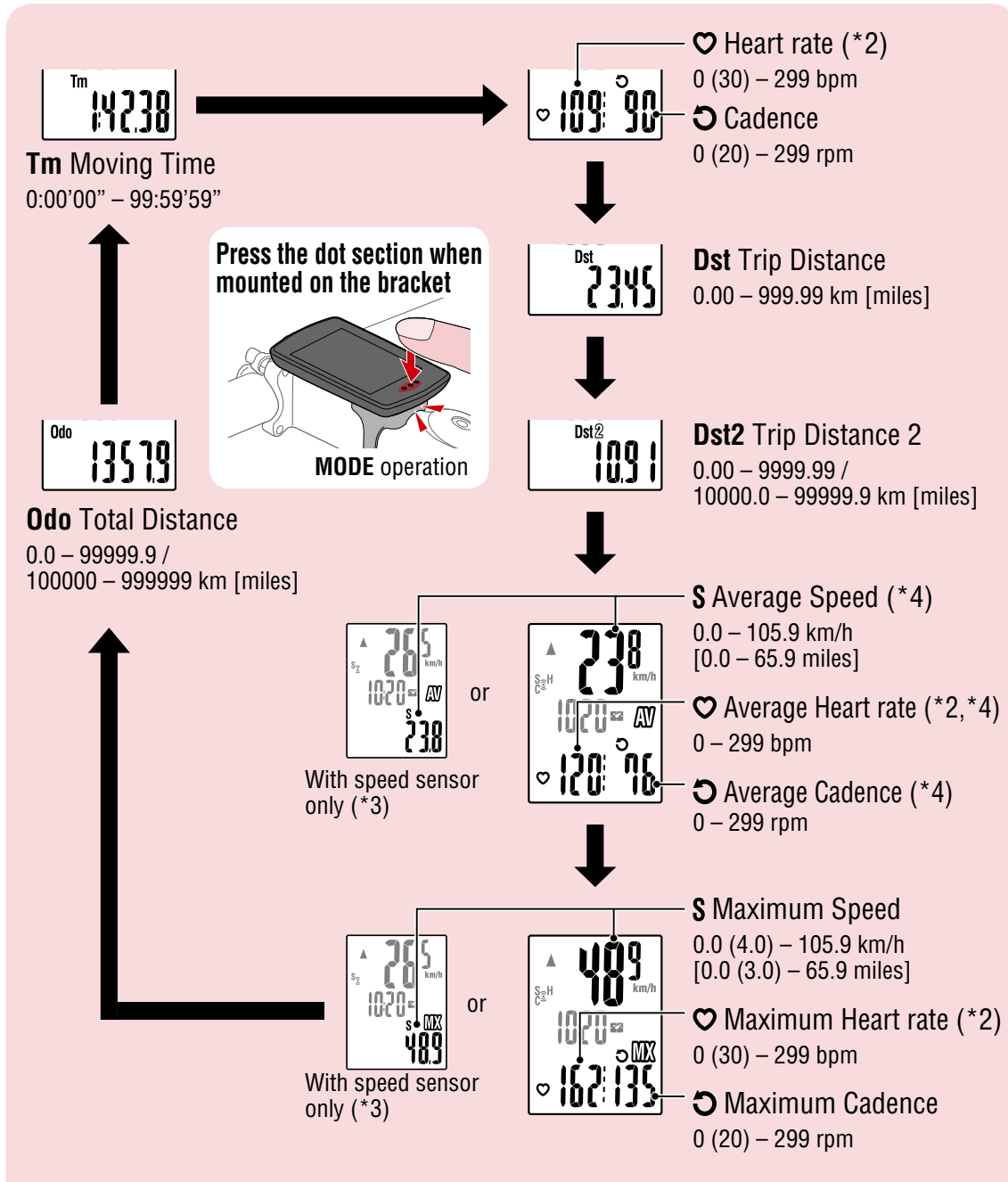

Using the unit  
Using the app

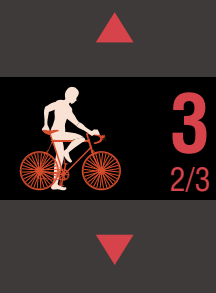

\*2: Heart rate data will not be displayed unless heart rate sensor is paired.

\*3: Regarding the average and maximum values, if only a speed sensor is paired, the upper display will show the current speed and the lower display will show the average speed or the maximum speed.

\*4: Average values are displayed as .E instead of the measured value when the moving time exceeds approximately 27 hours. The same applies to the average speed if the trip distance exceeds 1000 km.

\* If the speed, cadence, or heart rate value flashes, the battery of the measuring sensor has reached the end of its service life.

## Starting/stopping measurement

Measurement starts automatically when the bicycle moves.

During measurement the measurement unit (km/h or mph) flashes.

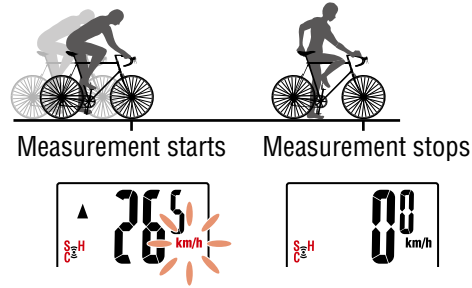

## Data reset (saving summary data)

Display data other than **Dst2** and press **MODE** for 2 second to reset all measurement data to 0 (excluding the total distance (**Odo**) and trip distance 2 (**Dst2**) values). At this time, the measurement results are saved as summary data to the internal memory of the PADRONE DIGITAL.

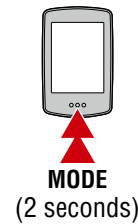

Using the unit

Using the app

\* The PADRONE DIGITAL can save up to 30 summary data files.

When the memory is full, **M** (memory alarm) is displayed on the screen and the oldest data is overwritten to save new summary data.

\* Importing summary data from the PADRONE DIGITAL's internal memory to a smartphone (Cateye Cycling™) clears the internal memory.

### ● Resetting trip distance 2 (Dst2)

Display **Dst2** and press **MODE** for 2 second to reset only **Dst2** to 0.



## Power-saving function

If the PADRONE DIGITAL does not receive any signal for 10 minutes, the power-saving screen is activated and only the clock is displayed. If **MODE** is pressed or a sensor signal is received while the power-saving screen is activated, the PADRONE DIGITAL returns to the measurement screen.

\* When the PADRONE DIGITAL is left on the power-saving screen for 1 hour, the display only shows the measurement unit. When the PADRONE DIGITAL is in this state, you can return to the measurement screen by pressing **MODE**.

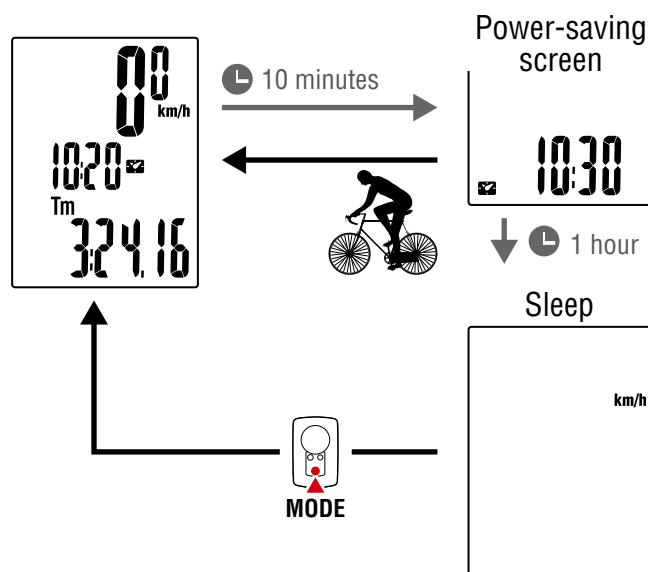

# Changing settings

[Menu screen]

On the measurement screen, press **MENU** to go to the menu screen.  
Various settings can be changed on the menu screen.

- \* After changing settings, always press **MENU** to confirm changes.
- \* When the menu screen is left on for 1 minute, the PADRONE DIGITAL returns to the measurement screen.

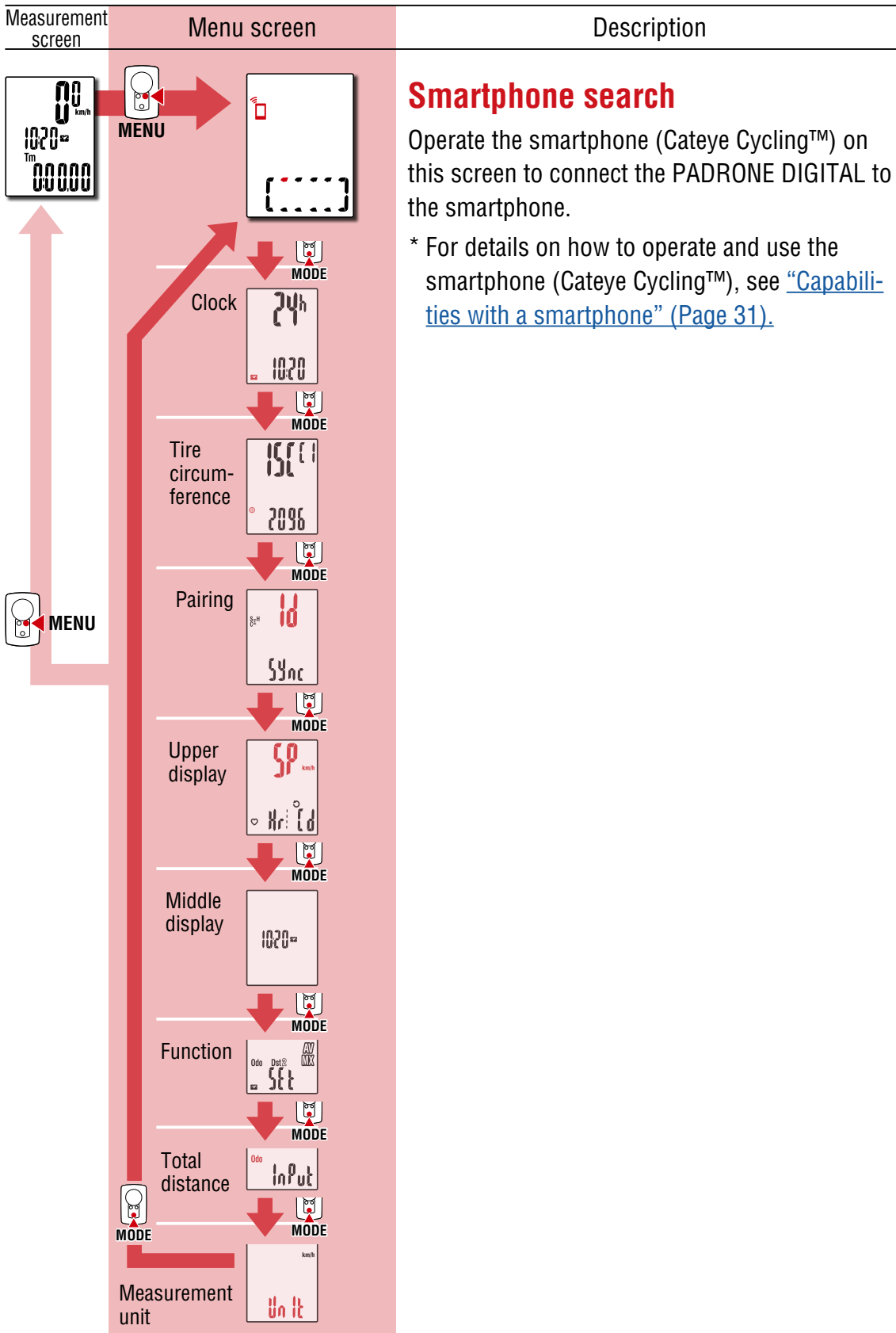

Using the unit  
Using the app



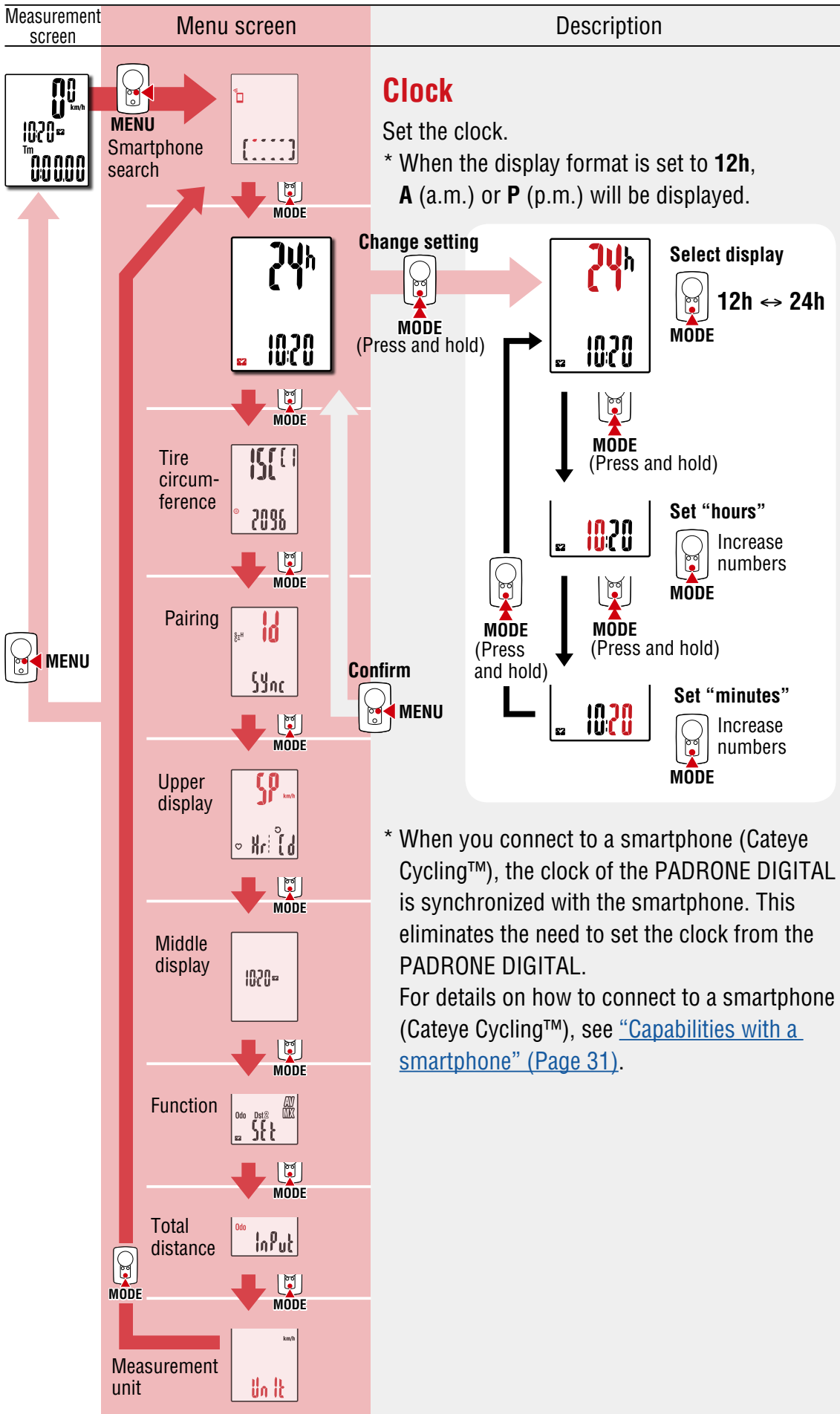

Using the unit  
Using the app



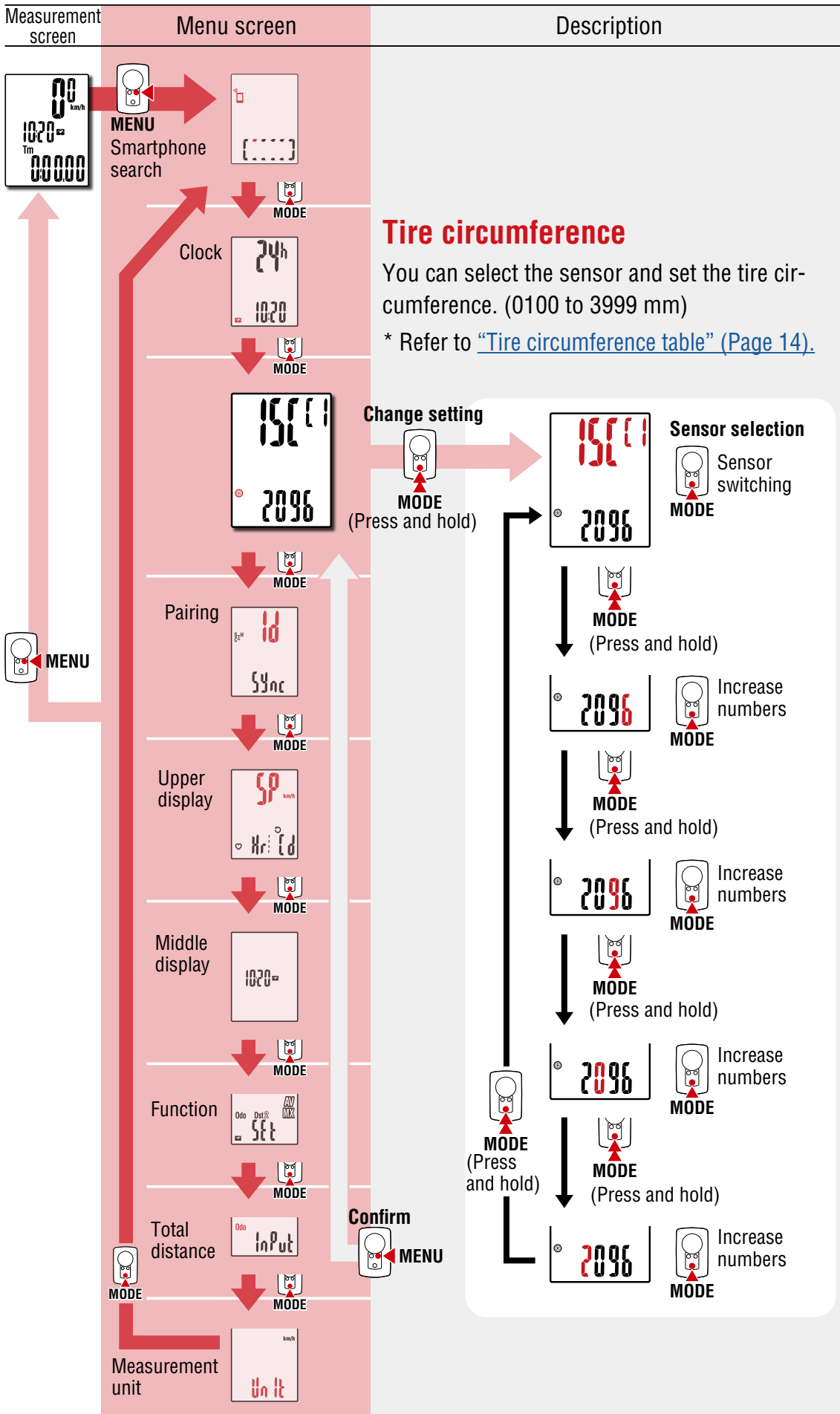

Using the unit  
Using the app





Measurement screen	Menu screen	Description									
		<h3>Pairing</h3> <p>You can pair the unit with a sensor.</p> <p><b>⚠ Caution!</b></p> <ul style="list-style-type: none"> <li>To use the PADRONE DIGITAL, you have to pair it with a sensor that supports the Bluetooth® SMART standard.</li> <li>Avoid pairing sensors at a race venue or in similar locations where there are a lot of other users. Doing so may cause the PADRONE DIGITAL to be paired with another device.</li> </ul>									
		<p><b>Change setting</b></p> <p> (Press and hold)</p> <p><b>Pairing standby screen</b> Use one of the methods in the following table to activate the sensor.</p> <p>Re-verify  (Press and hold)</p> <p>Sensor signal</p> <p><b>Pairing complete</b> The name of the sensor is shown in the upper display.</p>									
		<p><b>Confirm</b></p> <p> (Press and hold)</p> <p><b>Activating the sensor</b></p> <table border="1"> <thead> <tr> <th>CATEYE sensors</th> <th>Activation method</th> <th>Display</th> </tr> </thead> <tbody> <tr> <td>Speed/ Cadence sensor</td> <td>Move the magnet through the sensor zone several times. (Within 3 mm)</td> <td>ISC</td> </tr> <tr> <td>Heart rate sensor</td> <td>Rub both electrode pads with your thumbs.</td> <td>Hr</td> </tr> </tbody> </table> <p>* With the speed/cadence sensor and heart rate sensor, you can also activate the sensor by pressing the <b>RESET</b> button.</p> <p>* When pairing a sensor with the PADRONE DIGITAL, a "C" is displayed after the sensor name.</p> <p>* To continuously pair multiple sensors, hold down <b>MODE</b> without confirming the settings to return to the pairing standby screen, and then repeat the same procedure. Pair all sensors that you intend to use.</p>	CATEYE sensors	Activation method	Display	Speed/ Cadence sensor	Move the magnet through the sensor zone several times. (Within 3 mm)	ISC	Heart rate sensor	Rub both electrode pads with your thumbs.	Hr
CATEYE sensors	Activation method		Display								
Speed/ Cadence sensor	Move the magnet through the sensor zone several times. (Within 3 mm)	ISC									
Heart rate sensor	Rub both electrode pads with your thumbs.	Hr									



Using the unit

Using the app



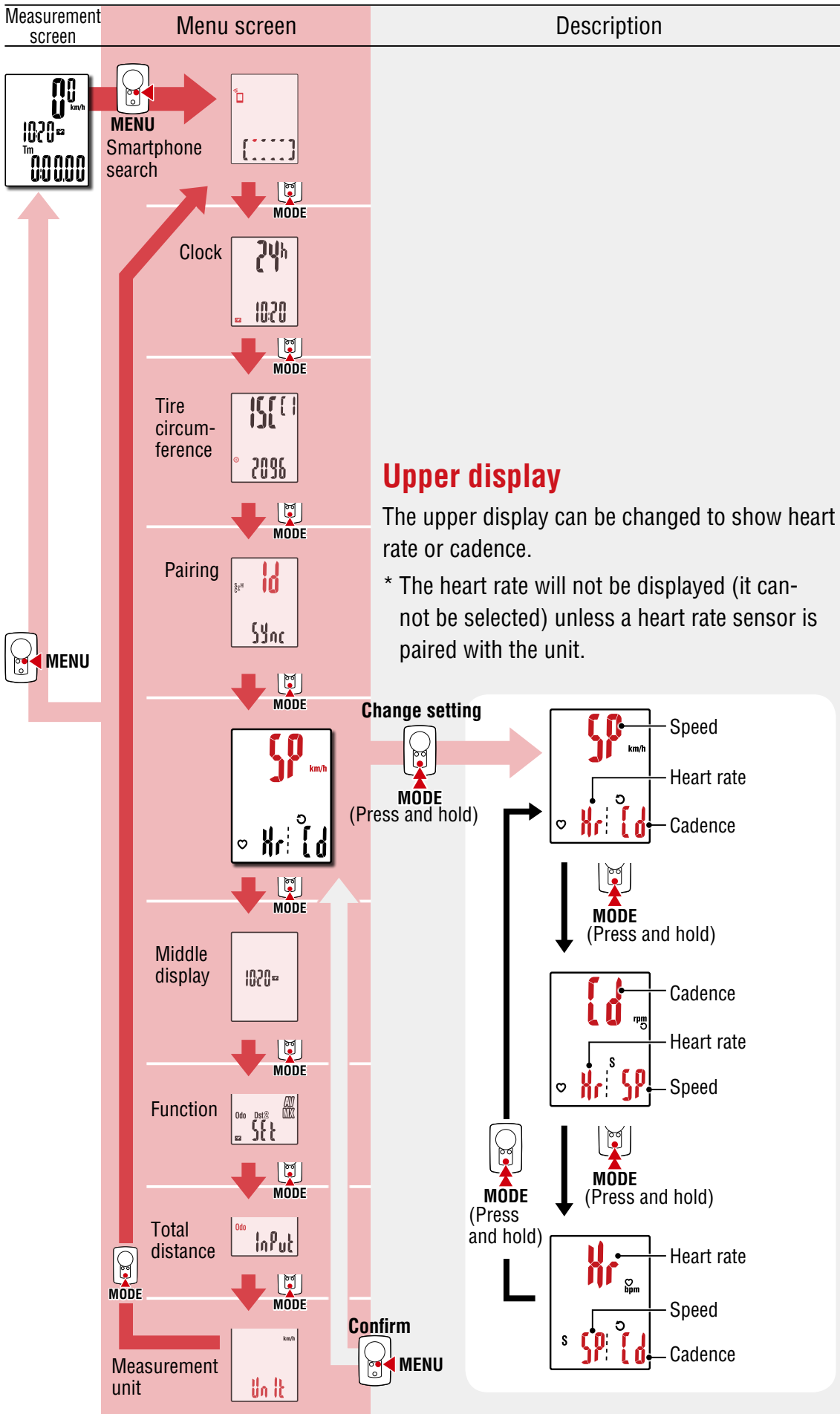

Using the unit

Using the app



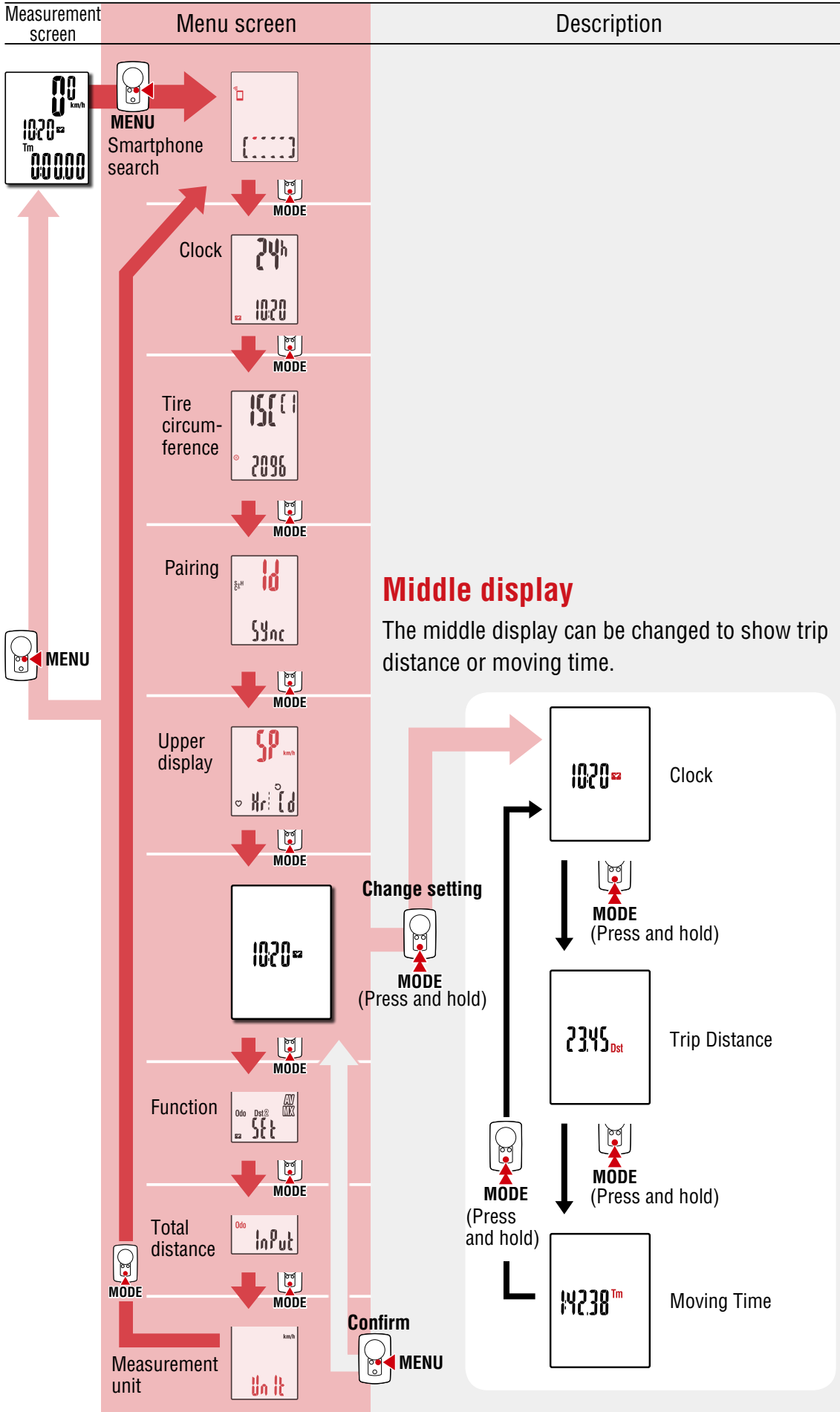

Using the unit

Using the app



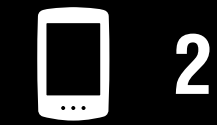
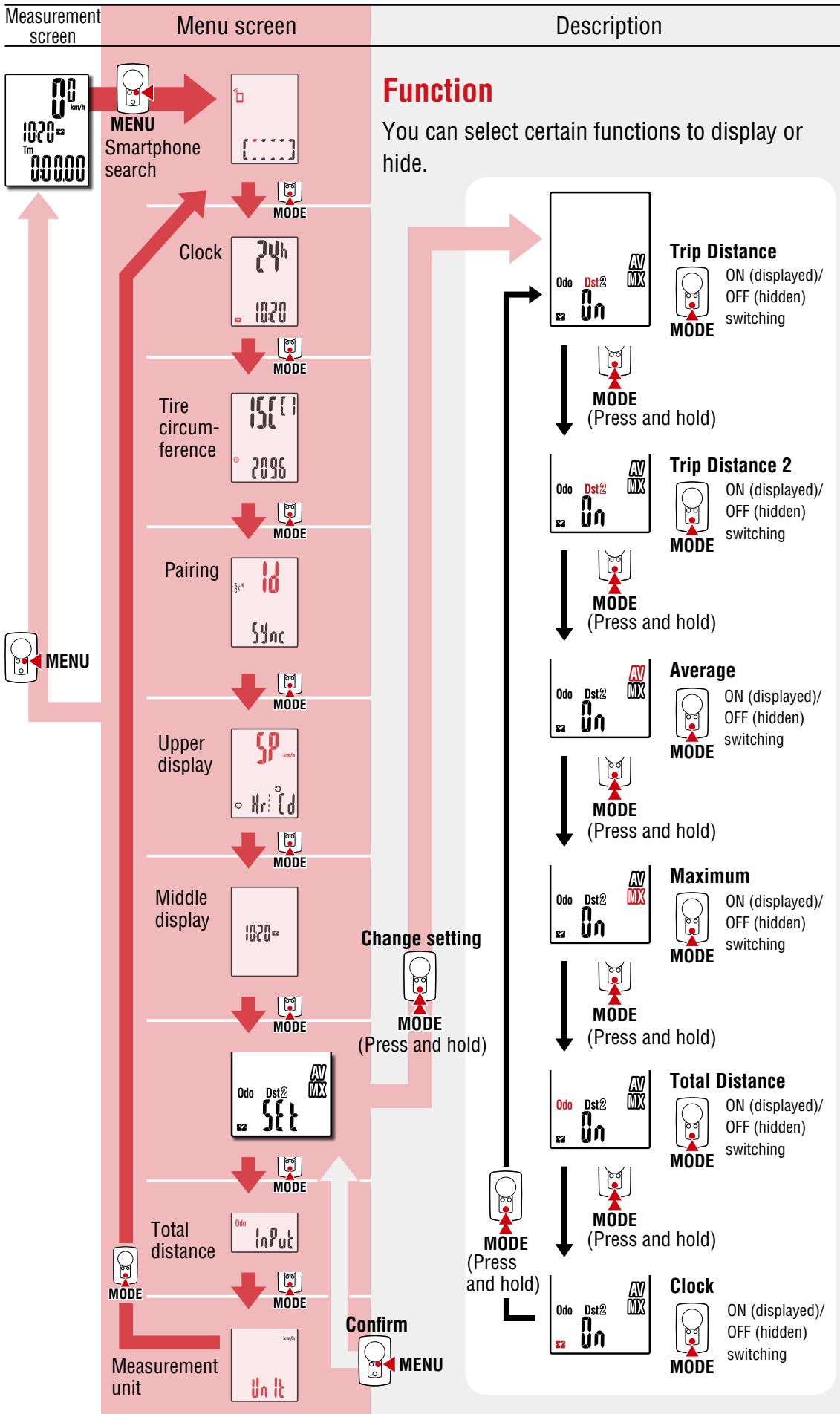

Using the unit  
Using the app



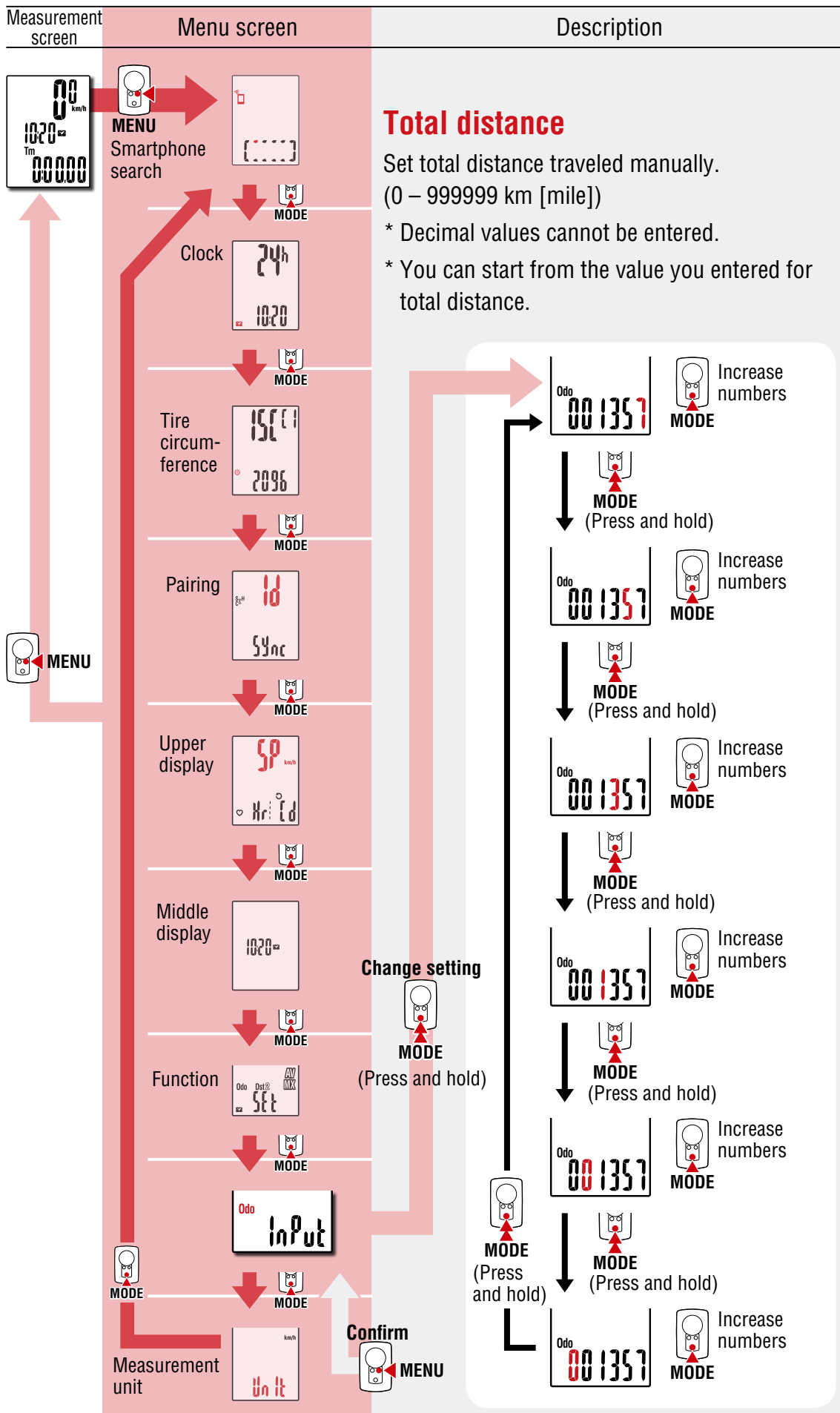

Using the unit  
Using the app

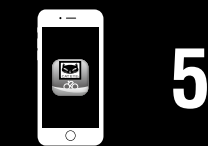
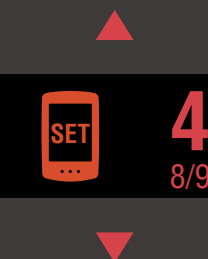

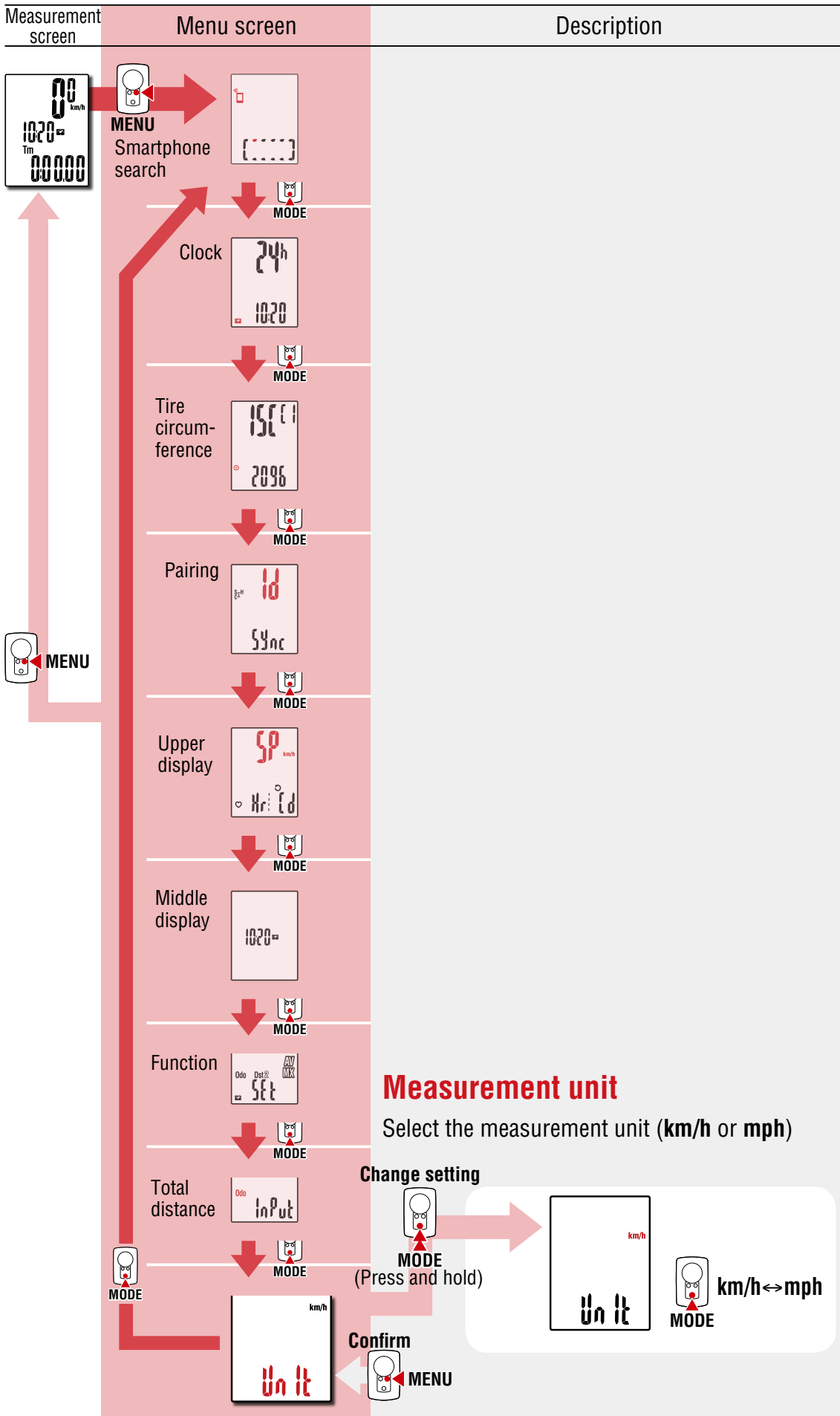

Using the unit  
Using the app



# Capabilities with a smartphone

By connecting the PADRONE DIGITAL to a smartphone (Cateye Cycling™), the measurement data can be managed and PADRONE DIGITAL settings changed from the smartphone.

To connect to a smartphone, install Cateye Cycling™ and perform pairing with PADRONE DIGITAL.

For instructions on installing/pairing with Cateye Cycling™, refer to procedures 1 to 5 in “Setup with a smartphone (Cateye Cycling™)” (Page 15).

The following can be performed on a smartphone (Cateye Cycling™).  
Please select the desired item.

- [Importing measurement results to a smartphone \(Page 32\)](#)
- [Check/upload the imported measurement results. \(Page 33\)](#)
- [Account settings \(Page 34\)](#)
- [Changing the measurement unit \(km/h or mph\) \(Page 35\)](#)
- [Measurement screen customization \(Page 36\)](#)
- [Input the initial settings for total distance \(Page 37\)](#)
- [Adding a new sensor \(Page 38\)](#)
- [Changing sensor tire circumference values \(Page 40\)](#)

\* Restart Cateye Cycling™ if a connection between a paired PADRONE DIGITAL cannot connect with the smartphone (Cateye Cycling™).  
If this does not resolve the issue, restart your smartphone.



1



2

Using the unit

Using the app



3



4



5

1/10



## Importing measurement results to a smartphone

\* You can import measurement results by connecting the PADRONE DIGITAL to a smartphone.

### PADRONE DIGITAL

**1** On the measurement screen, press **MENU** to display the smartphone search screen.

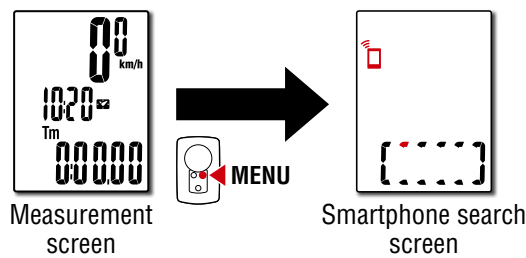

Using the unit

Using the app

### Smartphone

**2** Launch Cateye Cycling™, tap (Menu) and set [Connect] to ON. [Reading data from computer...] will be displayed and the smartphone will connect with the PADRONE DIGITAL. Then follow the procedure below.

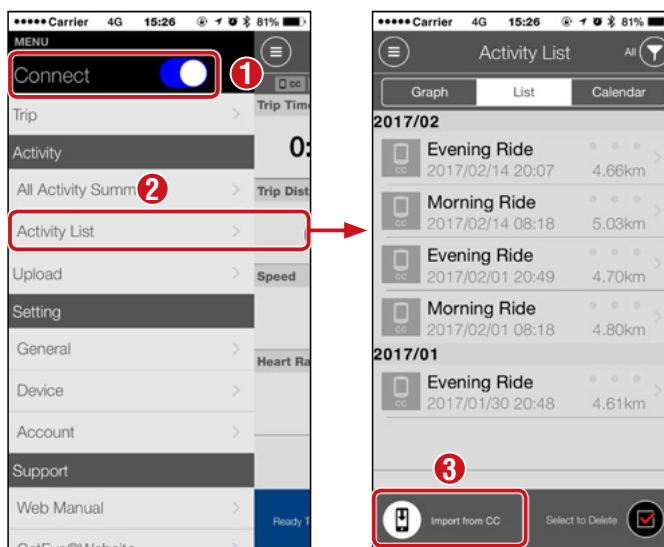

\* If summary data (Measurement results) is not saved on the PADRONE DIGITAL, the button is not displayed.

\* Measured values that have not been reset cannot be imported. Before connecting to a smartphone, perform reset operations with the PADRONE DIGITAL.

[“Data reset \(saving summary data\)” \(Page 21\)](#)

**3** Tap (Menu) at the top left of the screen, set [Connect] to OFF. The PADRONE DIGITAL disconnects from the smartphone and switches to the measurement screen.





**Check/upload the imported measurement results.**

\* You can check the measurement results and upload to service sites only on a smartphone.

**Smartphone**

**1** Launch Cateye Cycling™ and tap [Activity List] in (Menu). Then tap the screen in the following order.

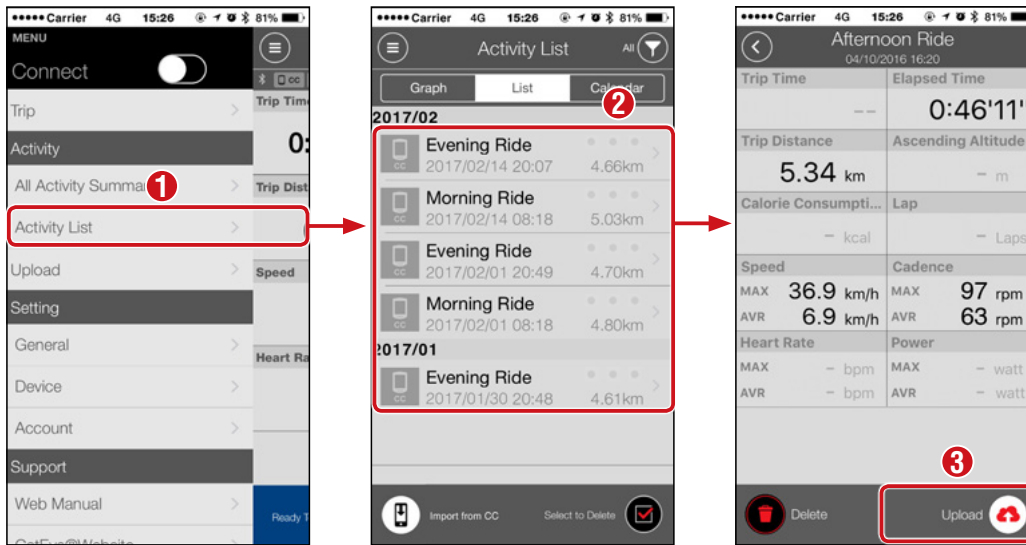

\* To upload, you must have a registered account with the relevant service site and [Account] settings on the next page must be completed.



Using the unit

Using the app

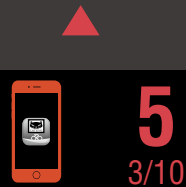

## Account settings

\* You can setup service site account only on a smartphone.

### Smartphone

- 1 Launch Cateye Cycling™ and tap [Account] in ☰ (Menu).  
Then tap the screen in the following order.

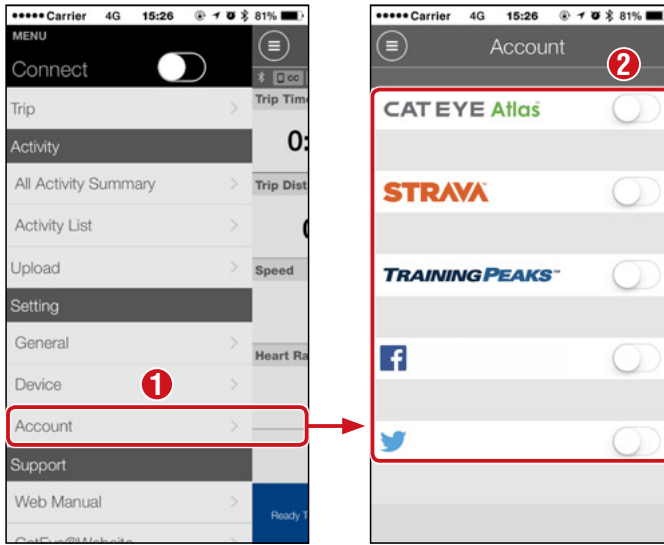

\* Activities can be posted to SNSs when uploading data to CATEYE Atlas™.



1



2

Using the unit

Using the app



3



4



5

4/10

## Changing the measurement unit (km/h or mph)

\* You can change the measurement units by connecting the PADRONE DIGITAL to a smartphone.

### PADRONE DIGITAL

**1** On the measurement screen, press **MENU** to display the smartphone search screen.

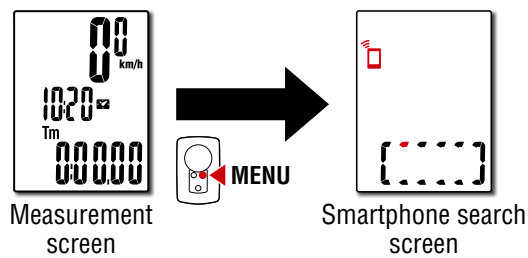

Using the unit

Using the app

### Smartphone

**2** Launch Cateye Cycling™, tap (Menu) and set [Connect] to ON. [Reading data from computer...] will be displayed and the smartphone will connect with the PADRONE DIGITAL. Then follow the procedure below.

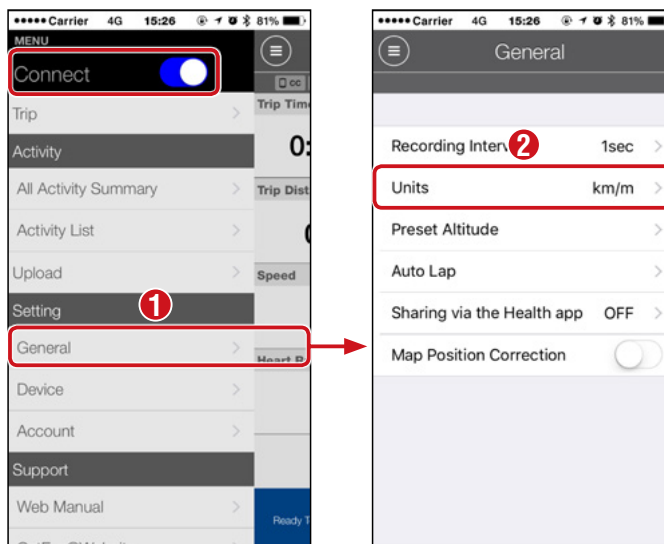

\* Settings other than for [Units] cannot be performed by the PADRONE DIGITAL.

**3** Tap (Menu) at the top left of the screen, set [Connect] to OFF. The PADRONE DIGITAL disconnects from the smartphone and switches to the measurement screen to which the setup details have been applied.



## Measurement screen customization

\* You can customize the measurement screen by connecting the PADRONE DIGITAL to a smartphone.

### PADRONE DIGITAL

**1** On the measurement screen, press **MENU** to display the smartphone search screen.

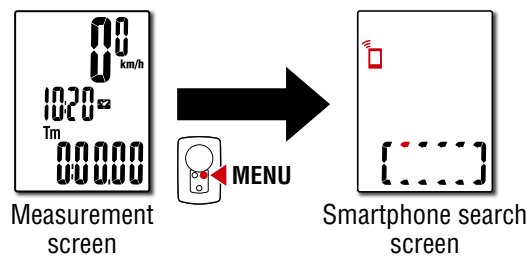

1

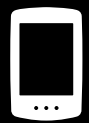

2

Using the unit

Using the app

### Smartphone

**2** Launch Cateye Cycling™, tap (Menu) and set [Connect] to ON. [Reading data from computer...] will be displayed and the smartphone will connect with the PADRONE DIGITAL. Then follow the procedure below.

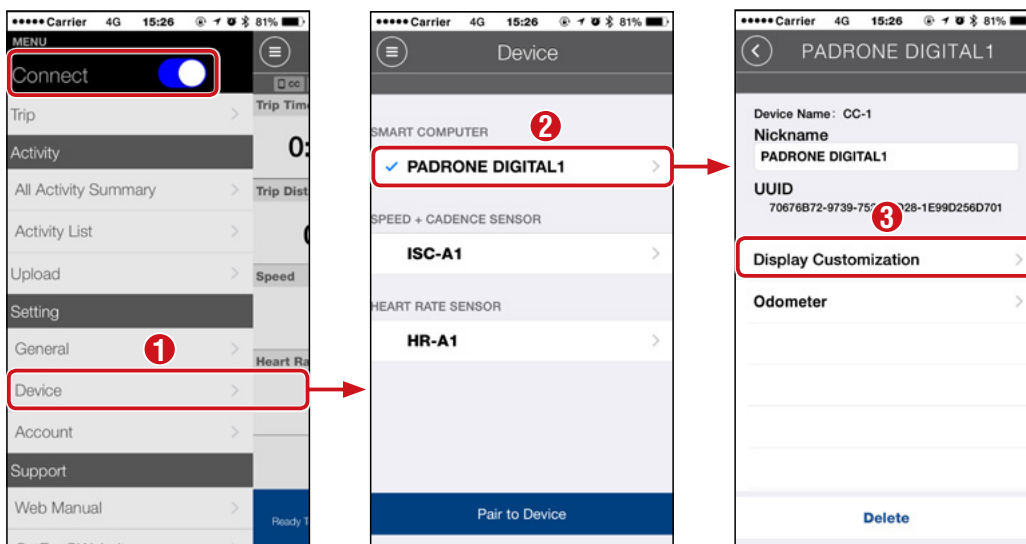

3



4

**3** Tap (Menu) at the top left of the screen, set [Connect] to OFF. The PADRONE DIGITAL disconnects from the smartphone and switches to the measurement screen to which the setup details have been applied.



5  
6/10

## Input the initial settings for total distance

\* You can input the total distance by connecting the PADRONE DIGITAL to a smartphone.

### PADRONE DIGITAL

- 1 On the measurement screen, press **MENU** to display the smartphone search screen.

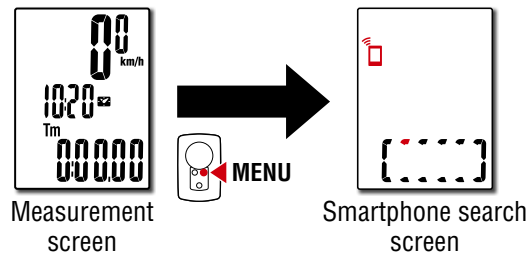

### Smartphone

- 2 Launch Cateye Cycling™, tap (Menu) and set [Connect] to ON. [Reading data from computer...] will be displayed and the smartphone will connect with the PADRONE DIGITAL. Then follow the procedure below.

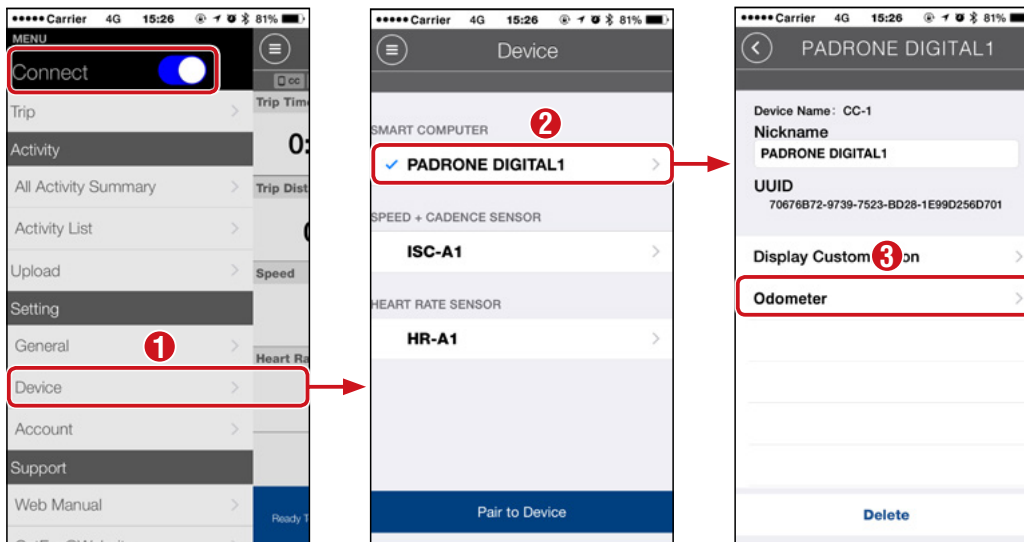

- 3 Tap (Menu) at the top left of the screen, set [Connect] to OFF. The PADRONE DIGITAL disconnects from the smartphone and switches to the measurement screen to which the setup details have been applied.



1



2

Using the unit

Using the app



3



4



5

7/10

## Adding a new sensor

### ⚠ Caution!:

- To use the PADRONE DIGITAL, you have to pair it with a sensor that supports the Bluetooth® SMART standard.
- Avoid pairing sensors at a race venue or in similar locations where there are a lot of other users. Doing so may cause the PADRONE DIGITAL to be paired with another device.

### ● Pairing of a commercial sensor and the PADRONE DIGITAL:

If using a commercial sensor with an iPhone, go back to  (Menu), set [Connect] to OFF and perform pairing with the PADRONE DIGITAL. [“Pairing” \(Page 25\)](#)

\* When using an iPhone, you cannot sync settings of commercial sensors with the PADRONE DIGITAL.

\* The sensor can be paired even when the PADRONE DIGITAL is not connected to a smartphone. In this case, sensor information will be synchronized with the PADRONE DIGITAL when connected to a smartphone.

### PADRONE DIGITAL

- 1 On the measurement screen, press **MENU** to display the smartphone search screen.

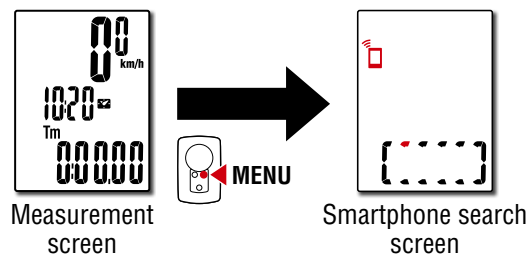

### Smartphone

- 2 Launch Cateye Cycling™, tap  (Menu) and set [Connect] to ON. [Reading data from computer...] will be displayed and the smartphone will connect with the PADRONE DIGITAL. Then follow the procedure on the next page.



1



2

Using the unit

Using the app



3



4



5

8/10

## Adding a new sensor

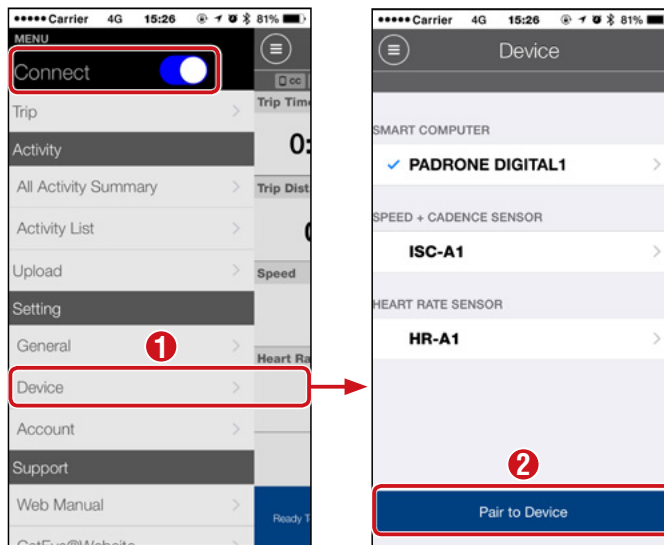

After tapping [Pair to Device], activate the added sensor using the procedure in the following table.

CATEYE sensors	Activating the sensor	Display
Speed/Cadence sensor	Move the magnet through the sensor zone several times. (Within 3 mm)	ISC
Heart rate sensor	Rub both electrode pads with your thumbs.	HR

\* With the speed/cadence sensor and heart rate sensor, you can also activate the sensor by pressing the **RESET** button.

When Cateye Cycling™ detects the sensor signal, a message is displayed on the smartphone.

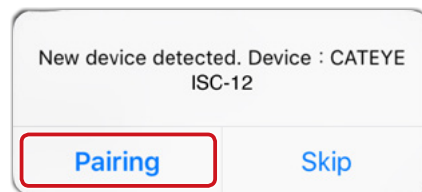

When [Pairing] is tapped, the name of the synchronized sensor is displayed and pairing is completed.

\* When pairing a sensor with Cateye Cycling™, an "A" is displayed after the sensor name.

- 3** Tap (Menu) at the top left of the screen, set [Connect] to OFF. The PADRONE DIGITAL disconnects from the smartphone and the new sensor will be ready to use.



Using the unit  
Using the app



## Changing sensor tire circumference values

\* You can change the tire circumference by connecting the PADRONE DIGITAL to a smartphone.

### PADRONE DIGITAL

**1** On the measurement screen, press **MENU** to display the smartphone search screen.

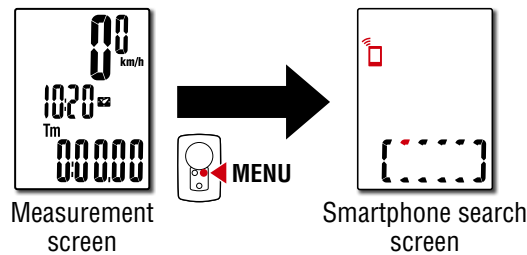

Using the unit

Using the app

### Smartphone

**2** Launch Cateye Cycling™, tap (Menu) and set [Connect] to ON. [Reading data from computer...] will be displayed and the smartphone will connect with the PADRONE DIGITAL. Then follow the procedure below.

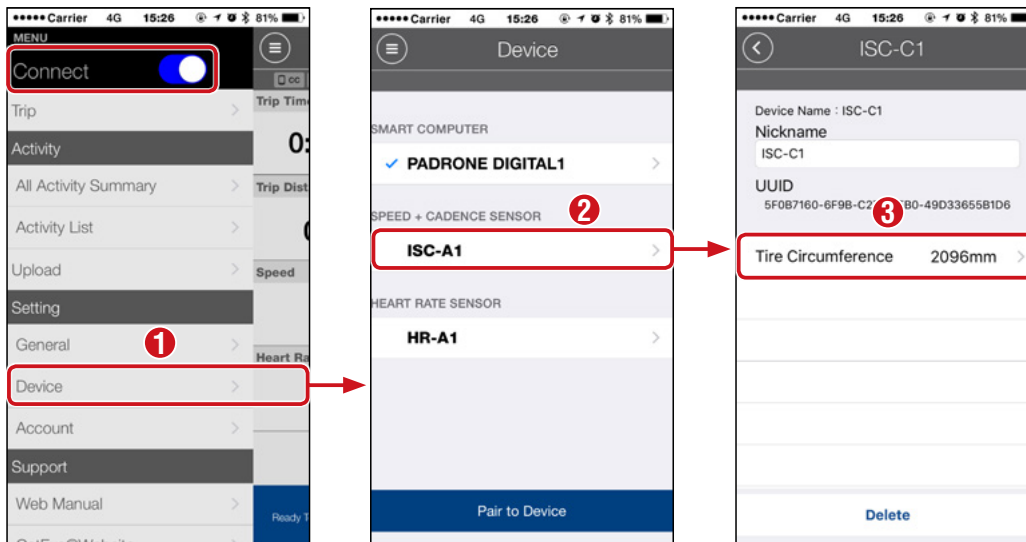

**3** Tap (Menu) at the top left of the screen, set [Connect] to OFF. The PADRONE DIGITAL disconnects from the smartphone and switches to the measurement screen to which the setup details have been applied.





# Appendix

## ⚠ Warning!!! / Caution!

### ⚠ Warning!!!:

- Do not concentrate on the PADRONE DIGITAL while riding. Always ride safely.
- Mount the magnet, sensor, and bracket securely, and check them periodically to ensure that they are not loose.
- If a battery is swallowed accidentally, consult a doctor immediately.

### ⚠ Caution!:

- Do not leave the PADRONE DIGITAL in direct sunlight for a long period of time.
- Do not disassemble the PADRONE DIGITAL.
- Do not drop the PADRONE DIGITAL. Doing so may result in malfunction or damage.
- When pressing the **MODE** button with the PADRONE DIGITAL installed on the bracket, press the area around the dot section on the front of the PADRONE DIGITAL. Pressing other areas strongly may result in malfunction or damage.
- Always tighten the bracket band dial by hand. Using a tool or other object to tighten the dial may crush the screw thread.
- When cleaning the PADRONE DIGITAL and accessories, do not use thinners, benzine, or alcohol.
- Risk of explosion if battery is replaced by an incorrect type.  Dispose of used batteries according to local regulations.
- The LCD screen may be distorted when viewed through polarized sunglass lenses.

## Bluetooth® Smart

Interference occurs in the following places and/or environments, which may result in an incorrect measurement.

- Near TVs, PCs, radios, or motors or in cars or trains.
- Near railroad crossings, along railway tracks, around television transmitting stations and radar bases, etc.
- When used together with other wireless devices (including other Bluetooth® products) or some particular battery lights.

CC-PA400B	Frequency Band: 2.4 GHz	Radiated Power: -5.7 dBm (0.269 mW) at EIPR
ISC-12	Frequency Band: 2.4 GHz	Radiated Power: -9.24 dBm
HR-12	Frequency Band: 2.4 GHz	Radiated Power: -0.09 dBm

Hereby, CATEYE Co., Ltd. declares that the radio equipment type CC-PA400B / ISC-12 / HR-12 is in compliance with Directive 2014/53/EU. The full text of the EU declaration of conformity is available at the following internet address: [cateye.com/doc](http://cateye.com/doc)

This device complies with Part 15 of the FCC Rules and Industry Canada licence-exempt RSS standard(s). Operation is subject to the following two conditions: (1) this device may not cause harmful interference, and (2) this device must accept any interference received, including interference that may cause undesired operation.

**Modifications** The FCC requires the user to be notified that any changes or modifications made to this device that are not expressly approved by CatEye Co., Ltd. may void the user's authority to operate the equipment.

**NOTE:** This equipment has been tested and found to comply with the limits for a Class B digital device, pursuant to Part 15 of the FCC Rules. These limits are designed to provide reasonable protection against harmful interference in a residential installation. This equipment generates, uses and can radiate radio frequency energy and, if not installed and used in accordance with the instructions, may cause harmful interference to radio communications. However, there is no guarantee that interference will not occur in a particular installation. If this equipment does cause harmful interference to radio or television reception, which can be determined by turning the equipment off and on, the user is encouraged to try to correct the interference by one or more of the following measures:  
Reorient or relocate the receiving antenna. Increase the separation between the equipment and receiver. Connect the equipment into an outlet on a circuit different from that to which the receiver is connected.  
Consult the dealer or an experienced radio/TV technician for help.  
This Class B digital apparatus complies with Canadian ICES-003.



1



2

Using the unit

Using the app



3



4



5

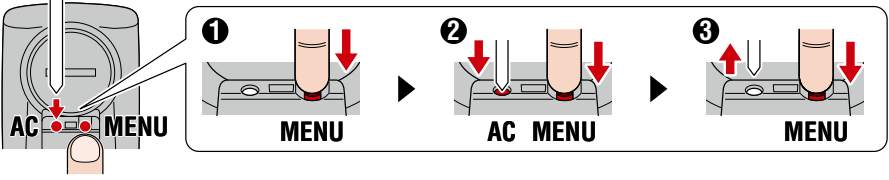
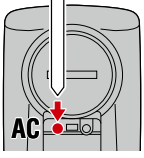

## Differences between formatting and restarting

Action	Description
Formatting	<p>Perform this action when you use the unit for the first time and when you delete all the measured data and return the settings to their default values.</p> <p><b>Operation</b></p> 
Restarting	<p>Perform this action when you replace the battery of the PADRONE DIGITAL or when its display is abnormal. Restarting maintains the data shown below.</p> <ul style="list-style-type: none"> <li>● Measurement unit</li> <li>● Clock</li> <li>● Sensor pairing information and tire circumference</li> <li>● Upper and middle displays</li> <li>● Function</li> <li>● Total distance</li> <li>● Summary data that has been reset and saved</li> </ul> <p><b>Operation</b></p> 

## Maintenance

If the PADRONE DIGITAL or accessories become dirty, clean with a soft cloth which is moistened with mild soap.



1



2

Using the unit

Using the app



3



4



5



## Replacing the battery

### ● PADRONE DIGITAL

When  (battery icon) is displayed on the screen, it is time to replace the battery. Install a new lithium battery (CR2032) with the (+) side facing upward.

- \* After replacing the battery, always press only the **AC** button to restart the unit. The total distance value and the setting values will be maintained.

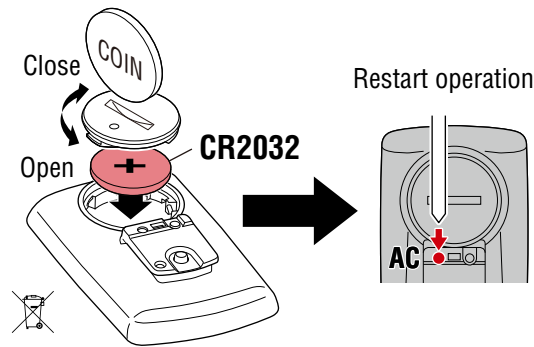

### ● Speed/Cadence sensor (ISC-12)

If the current speed or cadence display of the PADRONE DIGITAL starts flashing, it is time to replace the battery. Install a new lithium battery (CR2032) so that the (+) side is visible, and then close the battery cover securely.

- \* After replacing the battery, always press the **RESET** button on the back of the unit and adjust the position of the sensor relative to the magnet according to [“Mounting the speed/cadence sensor \(ISC-12\)”](#) (Page 5).

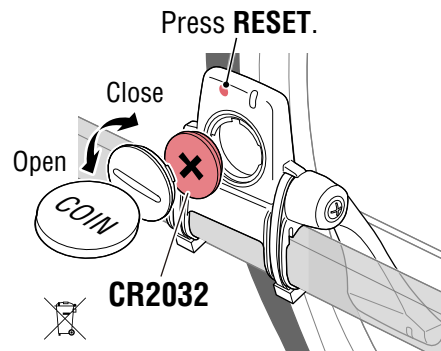

### ● Heart rate sensor (HR-12)

If the heart rate display of the PADRONE DIGITAL starts flashing, it is time to replace the battery. Install a new lithium battery (CR2032) so that the (+) side is visible, and then close the battery cover securely.

- \* After replacing the battery, always press the **RESET** button.

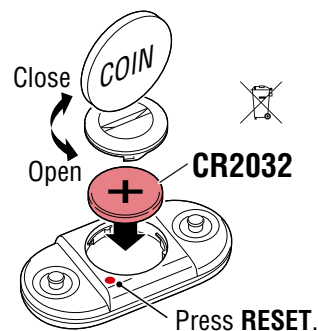

\* For detailed explanations on how to use CATEYE sensors such as mounting, or pairing, see [the sensor's Online Manual](#) (on our website) or the [Quick Start Manual](#) (PDF/ smartphone app).



Using the unit

Using the app



## Troubleshooting

### Measurement does not work

The PADRONE DIGITAL does not switch to the measurement screen.

What should I do?

- Is  flashing on the PADRONE DIGITAL?

The PADRONE DIGITAL is connected to a smartphone.

Set [Connect] to [OFF] in the  (Menu) of the smartphone (Cateye Cycling™) or close Cateye Cycling™.

### Why is the sensor signal not being received?

- If using a smartphone (Cateye Cycling™), is [Connect] set to [ON] in the  (Menu)?

Set [Connect] to [OFF] or close Cateye Cycling™.

- Are you using another smartphone application that is connecting to the Bluetooth® sensor?

The Bluetooth® sensor may be connected to the smartphone.

Bluetooth® sensors are only able to connect with a single device at a time.

Stop using all other apps or change the app settings so that it does not connect to Bluetooth® sensors.

- Turn off Bluetooth® on your smartphone, as the sensor may be connected to the smartphone.

Confirm that the sensor is connected.

It is recommended that Bluetooth® is turned off on your smartphone when the sensor disconnects easily.

- Are you also using other wireless devices simultaneously (including other Bluetooth® products)?

Stop using the devices simultaneously and confirm that the connection is restored.

- Press the **RESET** button on the sensor that cannot connect.

Confirm that the sensor is connected.



1

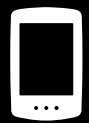

2

Using the unit

Using the app



3



4



5



## Troubleshooting

### Measurement does not work

#### Why is the sensor signal not being received? (Continued)

- Is the sensor paired with the unit?

The sensor must be paired with the PADRONE DIGITAL. Perform the pairing with the PADRONE DIGITAL or with a smartphone (Cateye Cycling™).

- PADRONE DIGITAL: [“Pairing” \(Page 25\)](#)
- Smartphone: [“Adding a new sensor” \(Page 38\)](#)

**⚠ Caution! Pairing of a commercial sensor and the PADRONE DIGITAL**

**If using a commercial sensor with an iPhone, go back to  (Menu), set [Connect] to OFF and perform pairing with the PADRONE DIGITAL.**

**[“Pairing” \(Page 25\)](#)**

**\* When using an iPhone, you cannot sync settings of commercial sensors with the PADRONE DIGITAL.**

- Is the PADRONE DIGITAL or sensor battery flat?

\* Battery performance diminishes in winter.

Replace the batteries with new ones as described in [“Replacing the battery” \(Page 43\)](#).

#### If speed sensor signals or cadence sensor signals are not received

- Is the clearance between the sensor zone of the sensor and the magnet too large? (The clearance must be within 3 mm.)
- Does the magnet pass through the sensor zone correctly?

Adjust the position of the magnet and/or the speed sensor.

#### If heart rate signals are not received

- The electrode pad may have slipped out of position.

Check that the electrode pad is still in close contact with your body.

- Your skin may be dry.

Wet the electrode pad a little.

- The electrode pad may have deteriorated or become damaged due to prolonged usage.

If this is the case, replace the attachment belt with a new one.



1

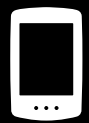

2

Using the unit

Using the app



3



4



5

## Troubleshooting

### Abnormal display

#### The display remains blank when the button is pressed.

Replace the PADRONE DIGITAL battery as described in [“Replacing the battery” \(Page 43\)](#).

#### Incorrect data appear.

Press only the **AC** button on the back of the PADRONE DIGITAL to restart it.  
The setting values will be maintained.

#### Why are measurement values flashing?

If using a Cateye sensor, measured values start flashing to indicate that there is little remaining battery life in the relevant sensor.

Refer to [“Replacing the battery” \(Page 43\)](#) to replace the battery for the relevant sensor.



1



2

Using the unit

Using the app

### Errors when using Cateye Cycling™ (Smartphone)

#### Cannot connect a paired PADRONE DIGITAL with a smartphone (Cateye Cycling™)

Restart Cateye Cycling™. If this does not resolve the issue, restart your smartphone.

#### Ⓜ (import button) to import summary data is not displayed in the Activity List

- Have you reset the PADRONE DIGITAL?

To import summary data using Cateye Cycling™, the PADRONE DIGITAL must be reset (**MODE** pressed for longer than 2 seconds on any display other than **Dst2**).

- If the PADRONE DIGITAL was reset but Ⓜ (import button) is not displayed:

Measurements for trips of 0.1 km or less are not recorded as summary data.

#### Cannot upload data

- Have you setup the account for each service site?

From Ⓜ (Menu) in the smartphone app (Cateye Cycling™), tap [Account] and enter the account information for each site.

- Cannot share on Facebook or Twitter

In Cateye Cycling™, tap Ⓜ (Menu) > [Account], and turn off Facebook and Twitter temporarily, and then turn them back on to solve the problem.



3



4



5

## Main specifications

Batteries used Battery life	PADRONE DIGITAL	Lithium battery (CR2032) x1 / Approx. 4 months
	Speed/cadence sensor (ISC-12)	Lithium battery (CR2032) x1 / Approx. 5 months
	Heart rate sensor (HR-12)	Lithium battery (CR2032) x1 / Approx. 5 months

- \* Life of pre-installed battery may be shorter than indicated above.
- \* Battery life may be reduced depending on the number of paired sensors and usage conditions.

Controller	4 bit, 1-chip microcomputer (Crystal controlled oscillator)	
Display	Liquid crystal	
Sensor	Non-contact magnetic sensor	
Signal transmission	Bluetooth® SMART	
Transmission distance	Approx. 30 m (The range will vary depending on weather and surroundings.)	
Tire circumference range	0100 mm – 3999 mm (Initial value: 2096 mm)	
Operating temperature range	32°F – 104°F (0°C – 40°C) (Guaranteed operating temperature range: Display visibility may deteriorate outside this range.)	
Dimensions/weight	PADRONE DIGITAL	2-21/32" x 1-11/16" x 39/64" (67.5 x 43 x 15.6 mm) / 1.06 oz (30 g)
	Speed/cadence sensor (ISC-12)	2-49/64" x 3-25/64" x 59/64" (70.4 x 86.3 x 23.5 mm) (With arm pointing down, not including rubber pads) / 0.68 oz (19.2 g)
	Heart rate sensor (HR-12)	1-7/32" x 2-29/64" x 15/32" (31 x 62.5 x 11.8 mm) (Not including HR strap) / 0.61 oz (17.3 g)

\* Specifications and design are subject to change without notice.

## Standard accessories

**1600280N**  
Bracket band

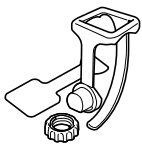

**1603970**  
Speed/Cadence sensor (ISC-12)



**1699691N**  
Wheel magnet



**1699766**  
Cadence magnet

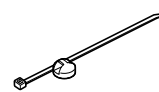

**1602193**  
Bracket



**1603980**  
Heart rate sensor (HR-12)

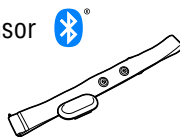

**1603595**  
HR strap

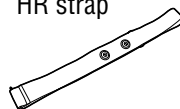

**1665150**  
Lithium battery (CR2032)



## Optional accessories

**1604100**  
Out-front bracket (OF-100)

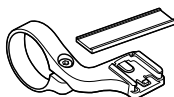

**1603892**  
Slim bracket kit



1



2

Using the unit

Using the app



3



4



5

## Limited warranty

### 2-year guarantee : PADRONE DIGITAL unit and included sensors (ISC-12 / HR-12) (Accessories and battery consumption excluded)

CatEye cycle computers are warranted to be free of defects from materials and workmanship for a period of two years from original purchase. If the product fails to work due to normal use, CatEye will repair or replace the defect at no charge. Service must be performed by CatEye or an authorized retailer. To return the product, pack it carefully and enclose the warranty certificate (proof of purchase) with instruction for repair. Please write or type your name and address clearly on the warranty certificate. Insurance, handling and transportation charges to CatEye shall be borne by person desiring service.

For UK and REPUBLIC OF IRELAND consumers, please return to the place of purchase. This does not affect your statutory rights.

## CATEYE CO., LTD.

2-8-25, Kuwazu, Higashi Sumiyoshi-ku, Osaka 546-0041 Japan

Attn: CATEYE Customer Service

Phone : (06)6719-6863

Fax : (06)6719-6033

E-mail : support@cateye.co.jp

URL : <http://www.cateye.com>

### [For US Customers]

## CATEYE AMERICA, INC.

2825 Wilderness Place Suite 1200, Boulder CO 80301-5494 USA

Phone : 303.443.4595

Toll Free : 800.5.CATEYE

Fax : 303.473.0006

E-mail : [service@cateye.com](mailto:service@cateye.com)



1



2

Using the unit

Using the app



3



4



5

